

NIGHT COLLECTION

F. A. B. R.

M. B. S. W.

H. S. M. B.

P. C. V. T.

M. C. S.

Tisettanta
CONTEMPORARY HOME

LA NOSTRA STORIA MADE IN ITALY DAL 1970



Fondata nel 1970 in un clima di grande fermento culturale, ma anche di importanti lotte civili e politiche, si afferma subito nel settore dell'arredo, portando avanti la propria visione di design modulare e innovativo. In un mercato focalizzato sulle fasce alte di consumatori, Tisettanta, da sempre attenta al Made in Italy, afferma la sua visione di design accessibile a tutti, senza rinunciare al prestigio e all'eccellenza.

L'obiettivo dell'azienda è offrire molteplici soluzioni per ogni esigenza funzionale ed estetica. I prodotti Tisettanta sono un inno all'eleganza e alla raffinatezza, garanzia di qualità e stile. Un design semplice ma sofisticato, in cui la diversità dei materiali è combinata in maniera creativa. Proposte di assoluta originalità e dall'essenzialità formale che hanno sempre contraddistinto il design di Tisettanta. Tante le collaborazioni, nel corso degli anni, con designers e architetti: Antonio Citterio, Marco Zanuso, Paolo Piva, Paolo Francesco Zanotto, Fabrizio Zappa, Sebastiano Tosi e tanti altri che hanno contraddistinto l'azienda accrescendo il suo valore.

Tisettanta is a historic brand in the Italian contemporary furniture industry. It was established in 1970 during a great cultural turmoil and civil and political conflicts. It has asserted itself in the furniture sector bringing forward its vision for a modular and innovative design. In a market focused on the high-end consumers, Tisettanta has always given great attention to Made in Italy, confirming a design vision accessible to everyone, and focusing on the prestige and the excellence. The company's aim is the multiple solutions offer for any functional and aesthetic needs. Tisettanta products are a hymn to elegance and refinement, a guarantee of quality and style. A simple but sophisticated design where diversity of materials is combined in a creative way. Proposals of absolute originality and simplicity which have always characterized Tisettanta design. Over the years, many are the collaborations with designers and architects: Antonio Citterio, Marco Zanuso, Paolo Piva, Paolo Francesco Zanotto, Fabrizio Zappa, Sebastiano Tosi and many others that have enhanced the value of the company.

INDEX

FLAP	9
ROY	27
MODÍ	37
BISMARCK	51
SIGN	59
WINK	79
MOSAICO	87
HIDE	95
PULL	105
BAND	113
CLIDE	119
VISION	127
WALK-IN CLOSET	139
COMPLEMENTI	
LETTO AMANTIA	16
COMODINO BALL	21
LETTO AYAME	30
COMODINO BALL UNO	31
COLLEZIONE MODÍ	45
COMODINO SOPHIE	71
VANITY JULIET	135
TRAY	151
SCAPE	155
TECHNICAL	159

CENTOPERCENTO

Centopercento nasce come una collezione di armadi "senza confini". Versatilità, eleganza formale ed estrema funzionalità sono gli elementi chiave che propone Tisettanta per la sua collezione armadi. Sono forme essenziali e allo stesso tempo originali, che racchiudono uno spazio la cui funzione è totalmente personalizzabile. Diverse tipologie di aperture, dallo scorrevole sovrapposto alla sua versione complanare, dalla semplicità delle ante battenti alla complessità del sistema misto, il tutto arricchito da una vasta gamma di accessori e di finiture interne ed esterne. Uno stile che raggiunge la massima purezza estetica grazie alle maniglie che si integrano nell'insieme delle forme, alle linee grafiche che disegnano le superfici, ai toni neutri e luminosi dei materiali. Una collezione dall'aspetto contemporaneo in grado di interagire con l'ambiente circostante: forme pure che convivono con componenti estremamente moderni e con oggetti dal sapore antico, conferendo alla struttura una straordinaria versatilità estetica, oltre che funzionale.

Centopercento was born as a wardrobe collection "without limits". Versatility, formal elegance and functionality are the key points suggested by Tisettanta for its wardrobe collection. Essential and original lines define a space where function can be entirely customized.

Different types of opening, from the sliding system to the coplanar one, from the simplicity of hinged doors to the complexity of the mixed system, completed by a wide range of accessories and of internal and external finishes.

A high aesthetic style is achieved through the integrated handles, the graphic definition of surfaces, and through the neutral and bright colour of the materials.

A collection exhibiting a contemporary look capable of interacting with its surroundings: pure lines simultaneously coexisting with extremely modern and traditional elements, lending extraordinary aesthetic and functional versatility to the structure.



centopercento battente

FLAP

Un'anta avvolta, in tutta la sua altezza, da una fascia in legno massello che ne crea la maniglia. Disponibile nelle tre versioni: battente, scorrevole e coplanare.

An entire door wrapped in a strip of wood that creates the handle. Available in its three versions: hinged, sliding and coplanar.





Anta Flap battente in essenza spazzolata laccata colori.

Flap hinged door in colours lacquered brushed veneer.

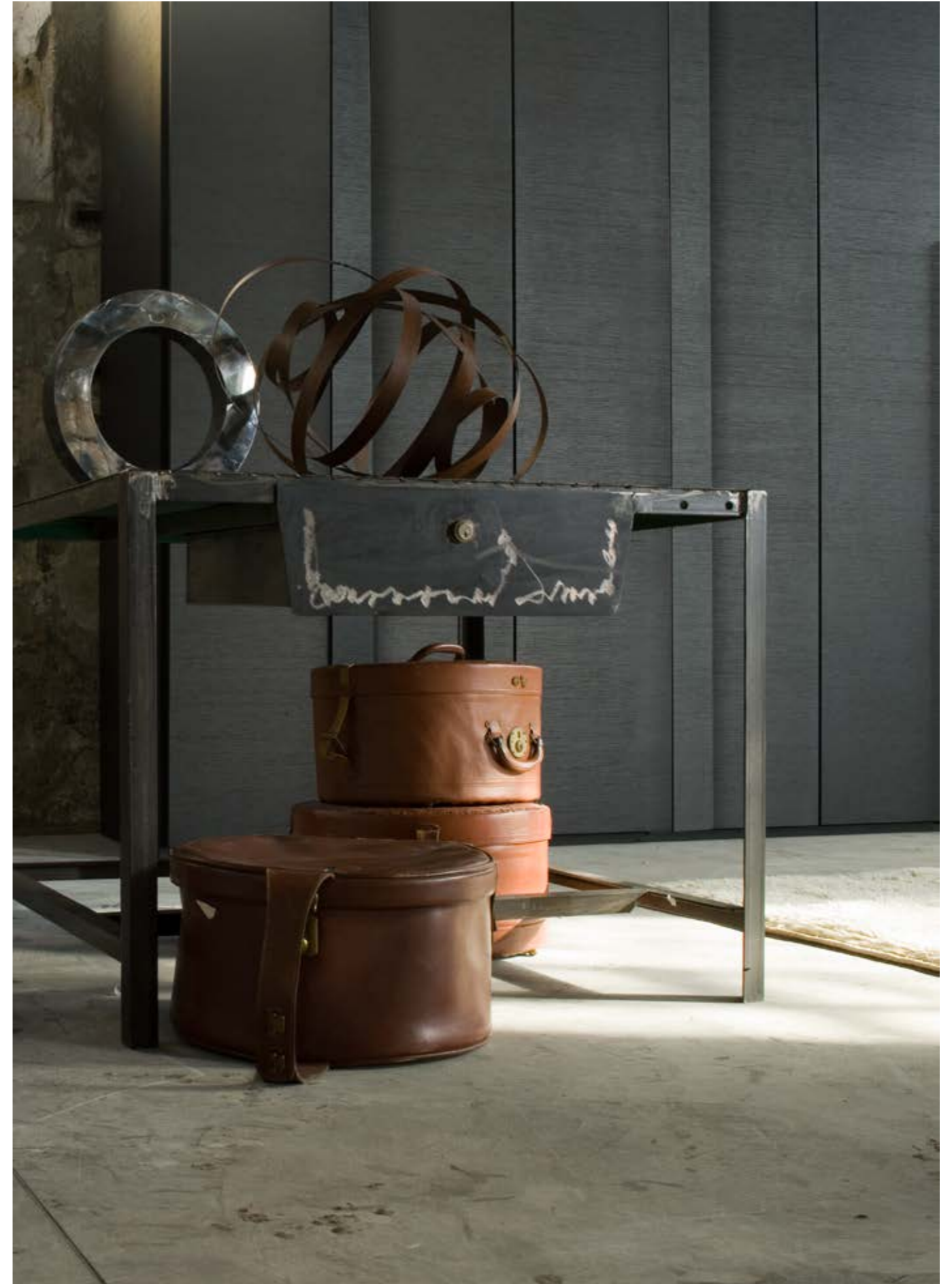



bed

AMANTIA

DESIGN PAOLO ZANOTTO



Frutto di un'accurata ricerca stilistica, Amantia si propone come fusione di volumi abbondanti e linee sobrie ed essenziali, creando un risultato di grande effetto.

Letto Amantia in velluto.

Anta Flap battente con pannelli rivestiti in tessuto Hitex e maniglia in essenza spazzolata laccata colori.

As a result of an accurate stylistic research, Amantia presents itself as a fusion of abundant volumes and soft and essential lines, creating an impressive result.

Amantia bed in velvet.

Flap hinged door with panels covered with Hitex fabric, colours lacquered brushed veneer handle.







night table

BALL



Comodino Ball a due cassetti in essenza rovere naturale.

Ball night table with two drawers in natural oak veneer.



centopercento complanare



Anta Flap complanare in essenza spazzolata laccata colori.
Struttura interna e attrezzatura in texwood.

Flap coplanar door in lacquered colours brushed veneer.
Internal structure and equipments in white and elm texwood finishing.

technical

FLAP



Maniglia Flap in essenza spazzolata colori.

Flap handle in colours lacquered brushed veneer.

Anta realizzata con pannello in particelle di legno con maniglia in massello di legno applicata.

Plane door in particle board and applied wooden handle.

Finiture:

- laccato seta colori
- essenza
- tessuto Hitex

Finishes:

- seta colour lacquer
- veneer
- Hitex fabric

Dimensioni Flap battente:

Altezze (mm): 2265 - 2425 - 2585
Larghezze (mm): 395 - 478 - 586

Flap hinged door dimensions:

Heights (mm): 2265 - 2425 - 2585
Widths (mm): 395 - 478 - 586

Dimensioni Flap complanare:

Altezze (mm): 2425 - 2585
Larghezze (mm): 961 - 1177 - 1444

Flap coplanar door dimensions:

Heights (mm): 2425 - 2585
Widths (mm): 961 - 1177 - 1444

Complanare / Coplanar door

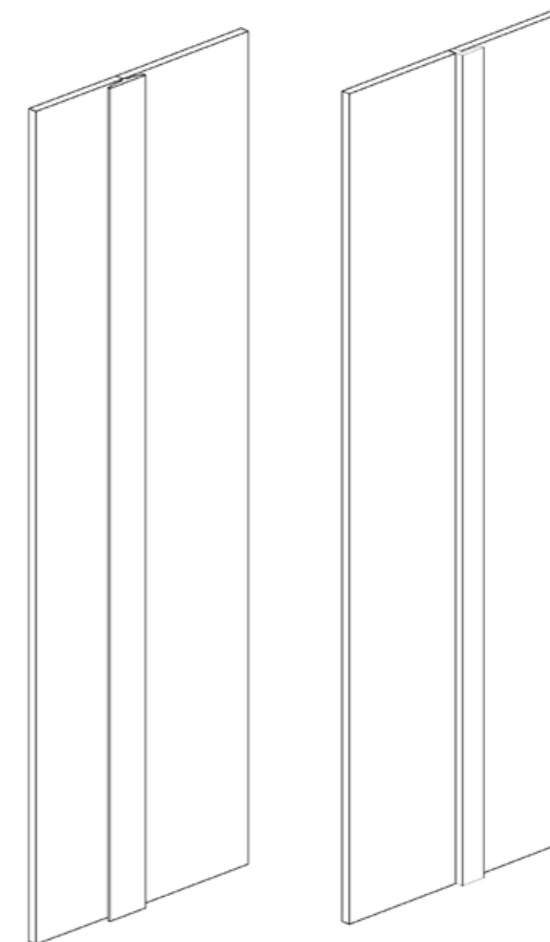
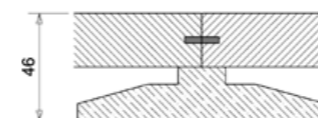

Battente / Hinged door

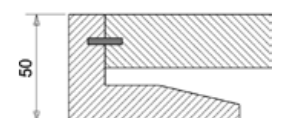



centopercento battente

ROY

La raffinatezza della maniglia verticale ricavata
nel pannello rende la semplicità dell'anta
battente Roy ancor più elegante.

The fineness of the carved-in vertical handle
makes the simplicity of the Roy door more
elegant.



bed

AYAME

DESIGN PAOLO ZANOTTO



Ispirato alle forme della tradizione, il letto Ayame si presenta con linee morbide e attuali che contribuiscono a creare un arredo estremamente versatile. La scelta delle finiture delle parti in legno e dei rivestimenti lo rende un vero protagonista dello spazio notte.

Letto Ayame in velluto. Comodino Ball Uno in essenza rovere naturale e base in metallo brunito.

Inspired by the traditional shapes, the Ayame bed introduces itself with smooth and gentle lines, that make it an extremely versatile piece of furniture. Thanks to the choice of the wooden and upholstered finishing, Ayame plays the role of the main character of the night area.

Ayame bed in velvet. Ball Uno night table in natural oak veneer and burnished metal base.







technical

ROY

Anta realizzata con pannello in fibra a media densità con maniglia ricavata direttamente nel pannello.

Plane door in medium density fibreboard with built-in handle

Finiture:

- laccato seta colori
- essenza

Finishes:

- seta colours lacquer
- veneer

Dimensioni:

Altezze (mm): 2265 - 2425 - 2585
Larghezze (mm): 395 - 478 - 586

Dimensions:

Heights (mm): 2265 - 2425 - 2585
Widths (mm): 395 - 478 - 586

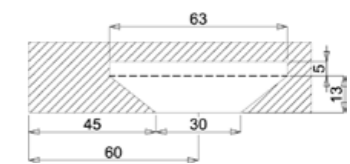
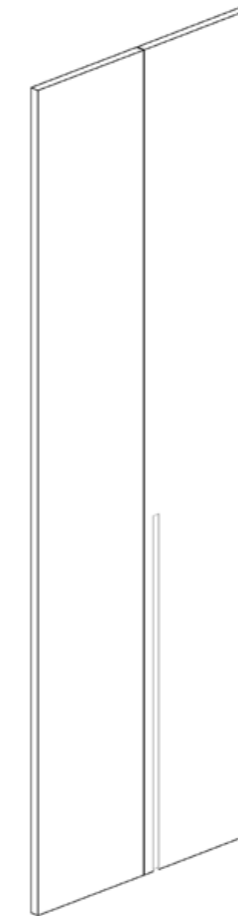



Centopercento battente

MODÌ

DESIGN FABRIZIO ZAPPA

Un profilo quasi scultoreo, con linee sinuose e bordi smussati che donano morbidezza ad un'anta battente dalla silhouette femminile.

A contour that reminds that of a sculpture, with gentle lines and rounded edges, that gives smoothness to an hinged door, symbol of elegance and beauty.



Anta Modi battente laccata seta colori con inserti in pelle e luci integrate.

Modi hinged door in colours lacquered finishing, with leather inserts and integrated lights.







bed
MODÌ
 DESIGN FABRIZIO ZAPPA



La struttura in massello rivestito sottolinea la morbidezza e l'equilibrio delle forme del letto Modì. I piedini in acciaio satinato conferiscono leggerezza, mentre l'accurata lavorazione artigianale, impreziosita dalle cuciture a vista, valorizza l'aspetto materico delle pelli di finitura.

The structure in upholstered solid wood highlights the softness and the balance of the shapes of the Modì bed. The satin stainless steel feet confer lightness, while the accurate workmanship, decorated by visible stitchings, enhances the precious leather finishes.

chest of drawers

MODÌ

DESIGN FABRIZIO ZAPPA



Cassettiera a 7 cassetti con luce.
Finitura in essenza spazzolata laccata colori e pelle.

Chest of 7 drawers with light.
Colours lacquered brushed veneer finish and leather.





technical

MODÌ

Anta realizzata con pannello in fibra a media densità. Impianto LED incluso, ricavato all'interno della maniglia.

Composizione colonna L 966:
anta sagomata L 586 + anta raggiata L 370
Composizione colonna L 1182:
anta sagomata L 586 + anta raggiata L 586

Finiture:

- laccato seta colori con inserto in pelle

Dimensioni:

NON SONO POSSIBILI TAGLI A MISURA
Altezze (mm): 2585
Larghezza anta sagomata (mm): 586
Larghezza anta raggiata (mm): 370 - 586

Plane door with a medium density fibreboard.

Composition for a column W 966:
shaped door W 586 + rounded door W 370
Composition for a column W 1182:
shaped door W 586 + rounded door W 586

Finishes:

- seta colours lacquer with leather insert

Dimensions:

CUTS ON SIZE ARE NOT POSSIBLE
Heights (mm): 2585
Width for shaped door (mm): 586
Width for rounded door (mm): 370 - 586

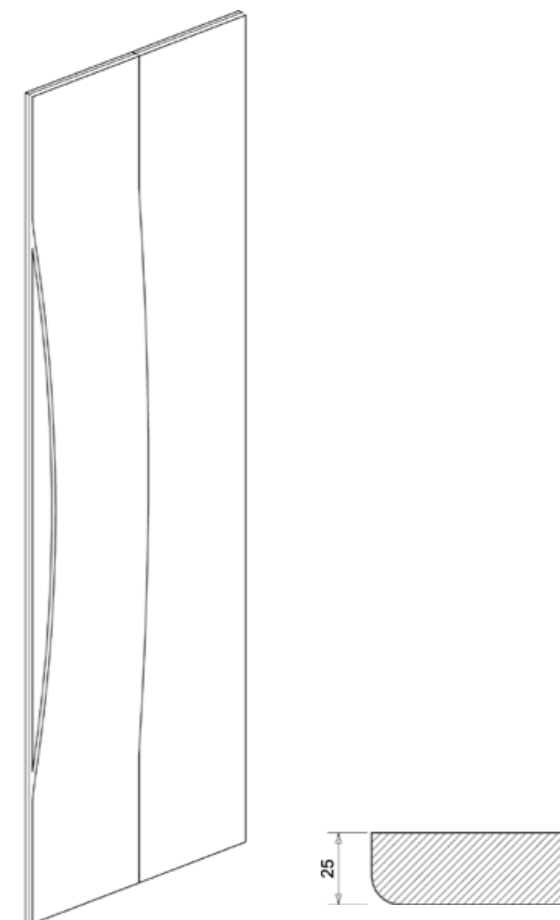



centopercento battente

BISMARK

La lucentezza del vetro retroverniciato o dello specchio, accostata al profilo maniglia laccato o brunito, conferisce personalità ed originalità all'anta battente Bismark.

The brightness of the back-painted glass or the mirror, matched with the lacquered or burnished handle profile, lends personality and originality to the Bismark hinged door.







technical

BISMARK

Anta realizzata con pannello in particelle di legno, facciata in vetro retroverniciato o specchio, con profili verticali in metallo brunito o laccato.

Finiture:

- pannello posteriore: texwood (come struttura interna armadio)
- pannello frontale: vetro retroverniciato o specchio

Dimensioni:

Altezze (mm): 2265 - 2425 - 2585
Larghezze (mm): 395 - 478 - 586

Door in particle board with burnished metal or lacquered vertical edges and back-painted glass or mirror front.

Finishes:

- back panel: texwood (as the internal structure)
- front panel: back-painted glass or mirror

Dimensions:

Heights (mm): 2265 - 2425 - 2585
Widths (mm): 395 - 478 - 586

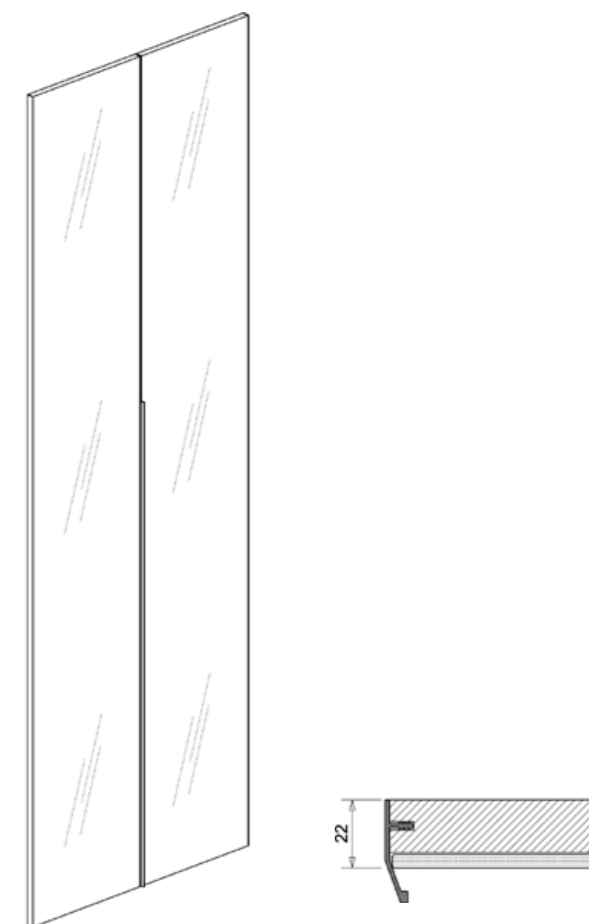



centopercento battente

SIGN

La semplicità dell'anta piana dalla superficie unica e minimalista, abbinata alle molteplici finiture disponibili, contribuisce all'essenzialità formale che distingue Sign. Disponibile nella versione battente e nella versione complanare.

The simplicity of a plain door with a unique and minimalist surface, with the variety of available finishes, contributes to the formal essence of the Sign hinged door. Available as hinged door or coplanar door.





Anta Sign battente laccato seta colori. Struttura interna e attrezzatura in olmo text.

Lacquered seta colours Sign hinged door. Internal structure and equipments in elm text finish.





Anta Sign battente in texwood.

Sign hinged door in texwood.







Anta Sign battente in tessuto Hitex.
Letto Ayame in velluto.

Sign hinged door in Hitex fabric.
Ayame bed in velvet.





night table

SOPHIE

DESIGN PAOLO ZANOTTO



Comodino Sophie in essenza rovere tinto cognac con gambe in massello,
top in vetro temprato retro verniciato o marmo.

Sophie night table in cognac dyed oak veneer with solid wood feet,
top in tempered back-painted glass or marble.



centopercento complanare

SIGN

Con una superficie più grande contraddistinta dalle stesse semplici linee, Sign è disponibile anche nella versione complanare.

With the same simple lines that characterise a bigger surface, Sign is available in its coplanar version.





technical

SIGN

Anta piana realizzata con pannello in particelle di legno.

Plane door in particle board.

Finiture:

- texwood
- laccato seta colori
- laccato lucido colori
- essenza
- tessuto Hitex

Finishes:

- texwood
- seta colours lacquer
- glossy colours lacquer
- veneer
- Hitex fabric

Dimensioni Sign battente:

Altezze (mm): 2265 - 2425 - 2585
Larghezze (mm): 395 - 478 - 586

Dimensions Sign hinged door:

Heights (mm): 2265 - 2425 - 2585
Widths (mm): 395 - 478 - 586

Dimensioni Sign complanare:

Altezze (mm): 2425 - 2585
Larghezze (mm): 961 - 1177

Dimensions Sign coplanar door:

Heights (mm): 2425 - 2585
Widths (mm): 961 - 1177

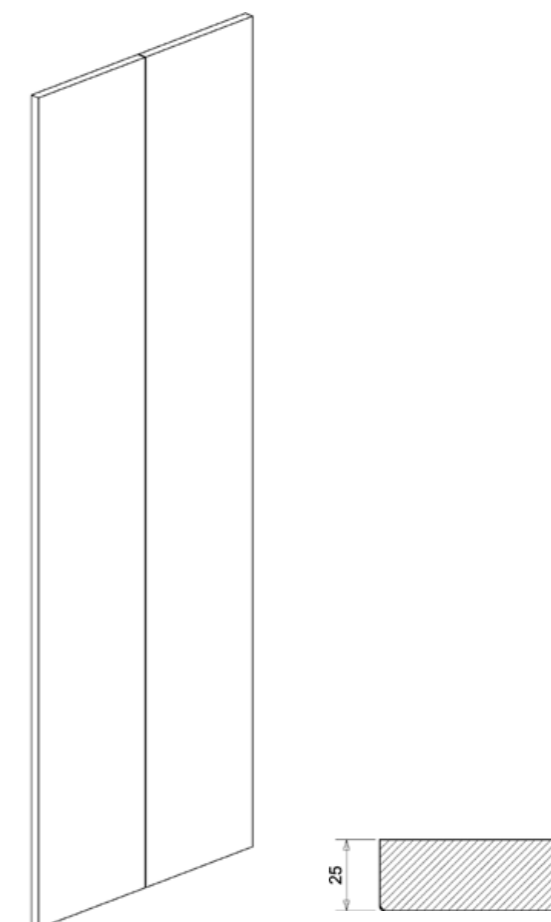



centopercento battente

WINK

Un'anta battente con pannelli frontali laccati o in pelle, che esprime la propria personalità creando un disegno geometrico dallo stile ben definito.

Hinged door with lacquered or leather front panels, expressing its own personality through a well-defined geometric pattern.





technical

WINK



Anta battente Wink con frontali in pelle.
Wink hinged door with leather front panels.

Anta piana realizzata con pannello in particelle di legno.

Plane door in particle board.

Finiture:

Pannello posteriore:
- Laccato seta colori
Pannelli frontali:
- Laccato seta colori
- Laccato lucido colori
- Pelle

Finishes:

Back panel:
- Seta colours lacquer
Front panel:
- Seta colours lacquer
- Glossy colours lacquer
- Leather

Dimensioni:

Altezze (mm): 2265 - 2425 - 2585
Larghezze (mm): 478 - 586

Dimensions:

Heights (mm): 2265 - 2425 - 2585
Widths (mm): 478 - 586

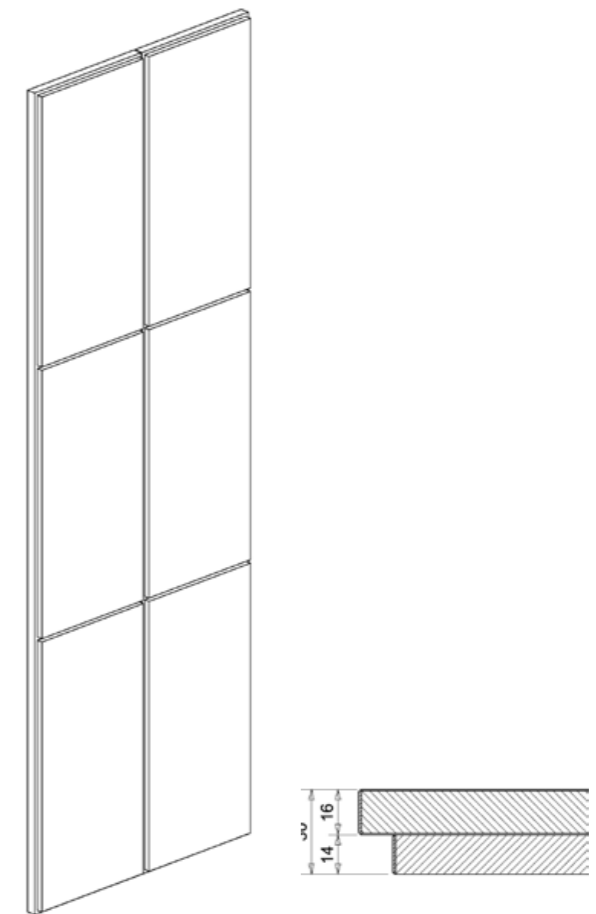



centopercento battente

MOSAICO

Un inserto in specchio o in vetro retro verniciato distingue l'anta Mosaico, e le conferisce un'elegante originalità

A mirror or a back-painted glass insert distinguishes the Mosaico door, and gives it an original elegance.







technical

MOSAICO

Anta realizzata con pannello in particelle di legno con fascia verticale in vetro retroverniciato / specchio.

Door in particle board with vertical band in back-painted glass / mirror

Finiture:

- laccato seta colori
- sssenza

Finishes:

- seta colours lacquer
- veneer

Dimensioni:

Altezze (mm): 2265 - 2425 - 2585
Larghezze (mm): 478 - 586

Dimensions:

Heights (mm): 2265 - 2425 - 2585
Widths (mm): 478 - 586

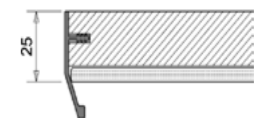
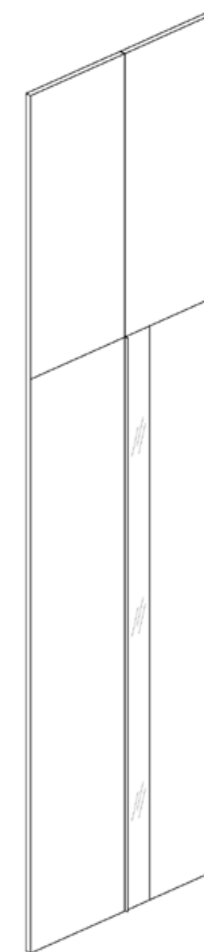



centopercento battente

HIDE

Un'anta battente o scorrevole con maniglia integrata in metallo brunito o laccata, dalla grande eleganza e personalità.

Hinged or sliding door with an integrated burnished metal or lacquered handle, a simple yet elegant product with personality.





Anta Hide battente in essenza spazzolata colori.

Hide hinged door in colours brushed veneer finish.





technical

HIDE

Anta piana realizzata con pannello in particelle di legno e maniglia in metallo brunito o laccata incorporata nell'anta.

Plane door in particle board and burnished or lacquered metal handle, built-in in the door.

Finiture:

- texwood
- laccato seta colori
- essenze
- tessuto Hitex

Finishes:

- texwood
- seta colours lacquer
- veneer
- Hitex fabric

Dimensioni:

Altezze (mm): 2265 - 2425 - 2585
Larghezze (mm): 395 - 478 - 586

Dimensions:

Heights (mm): 2265 - 2425 - 2585
Widths (mm): 395 - 478 - 586

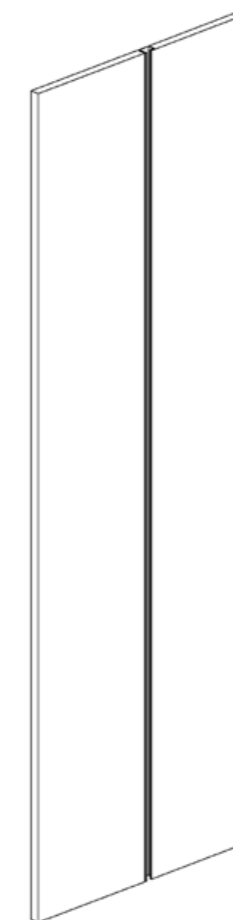



centopercento battente

PULL

Le linee minimaliste e la ricercatezza della maniglia concava ricavata dallo stesso pannello sono i tratti distintivi dell'anta battente Pull.

Minimalist lines and the preciousness of the integrated carved-in handle are the peculiarities of the Pull hinged door.



Anta Pull battente laccata seta colori.
Pull hinged door in seta colours lacquer







technical

PULL & CLIDE

Anta Pull battente laccata colori, anta scorrevole Clide in vetro retro verniciato.

Colours lacquered Pull hinged door, back-painted glass Clide sliding door.

Finiture:

- laccato seta colori
- essenza

Finishes:

- seta colours lacquer
- veneer

Dimensioni anta Pull battente:

Altezze (mm): 2265 - 2425 - 2585
Larghezze (mm): 395 - 478 - 586

Pull hinged door dimensions:

Heights (mm): 2265 - 2425 - 2585
Widths (mm): 395 - 478 - 586

Dimensioni anta Clide scorrevole:

Altezze (mm): 2265 - 2425 - 2585
Larghezze (mm): 818 - 985 - 1201

Clide sliding door dimensions:

Heights (mm): 2265 - 2425 - 2585
Widths (mm): 818 - 985 - 1201

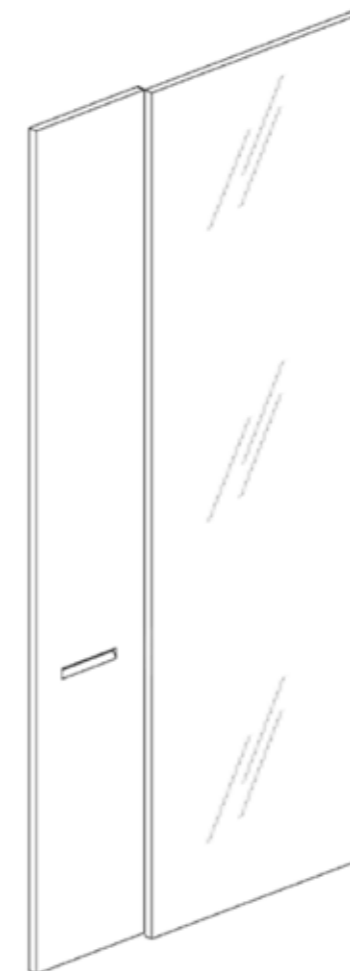



centopercento scorrevole

BAND

L'immagine di forte spessore dell'anta Band mette in risalto lo scorrimento elegante di un pannello laccato, arricchito da un inserto di vetro retroverniciato o specchio.

The strong image of the door of the Band door emphasizes the elegant sliding of a lacquered panel, with a back-painted glass or a mirror band.





technical

BAND

Anta piana realizzata in tamburato, con fascia centrale in vetro retroverniciato / specchio.

Finiture:

Pannello superiore ed inferiore:
- laccato seta colori
Pannello centrale:
- vetro retroverniciato / specchio

Dimensioni:

Altezze (mm): 2265 - 2425 - 2585
Larghezze (mm): 985 - 1201

Plane door with honeycomb structure with middle band in glass / mirror.

Finishes:

Upper and lower panel:
- colours seta lacquer
Central panel:
- back-painted glass / mirror

Dimensions:

Heights (mm): 2265 - 2425 - 2585
Widths (mm): 985 - 1201

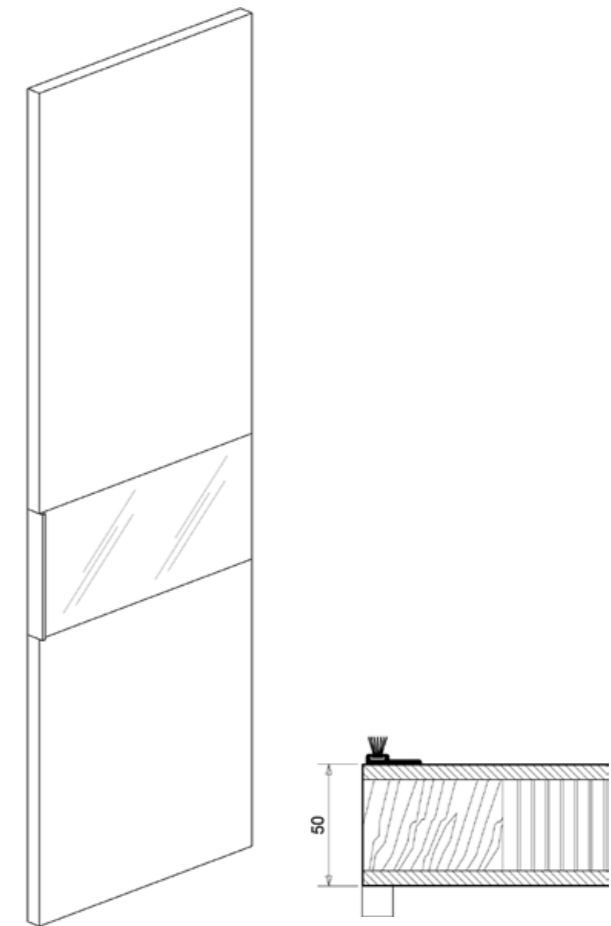



centopercento scorrevole

CLIDE

Estrema pulizia formale per quest'anta scorrevole, disponibile in molteplici finiture.

Elegance and minimalism for this sliding door, available in various finishes.



Anta Clide scorrevole in vetro retroverniciato lucido.

Back-painted glossy glass Clide sliding door.





technical

CLIDE

Anta piana realizzata con pannello in particelle di legno.

Plane door in particle board.

Finiture:

- texwood
- laccato seta colori
- laccato lucido colori
- essenze
- tessuto Hitex
- specchio / vetro retro verniciato

Finishes:

- texwood
- seta colours lacquer
- glossy colours lacquer
- veneer
- Hitex fabric
- back-painted glass / mirror

Dimensioni:

Altezze (mm): 2265 - 2425 - 2585
Larghezze (mm): 818 - 985 - 1201

Dimensions:

Heights (mm): 2265 - 2425 - 2585
Widths (mm): 818 - 985 - 1201

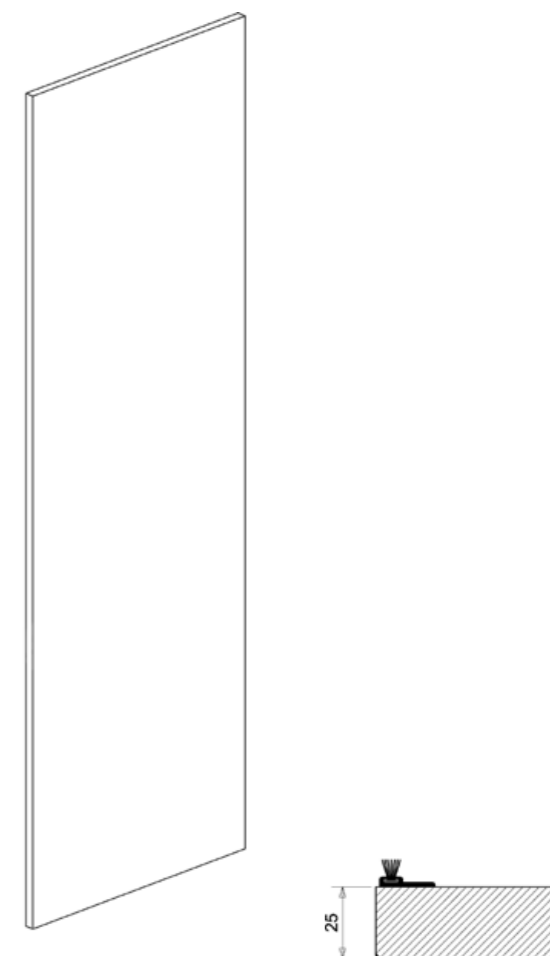

centopercento battente

VISION



Leggerezza e trasparenza del vetro caratterizzano l'anta Vision battente, incorniciata da un elegante telaio in metallo brunito. Disponibile con vetro extrachiaro, bronzato o nella versione a specchio.

Glass lightness and transparency characterise the Vision hinged door, enclosed by an elegant burnished metal frame. Available with extra bright or bronzed tempered glass, or mirror.





Armadio Vision con ante in vetro trasparente e profilo metallo brunito. Struttura interna e attrezzatura in texwood antracite.

Vision wardrobe with hinged doors in extra bright tempered glass and burnished aluminium frame. Internal structure and equipment in texwood anthracite.





vanity table

JULIET

DESIGN MATTEO BIANCHI



Vanity Juliet in massello rivestito in pelle e struttura in metallo curvato brunito.

Juliet vanity in leather covered solid wood and curved burnished metal.



technical

VISION

Anta realizzata con telaio in alluminio
brunito e vetro trasparente temprato.

Finiture:

- vetro extrachiaro
- vetro bronzato
- specchio

Dimensioni:

Altezze (mm): 2265 - 2425 - 2585
Larghezze (mm): 478 - 586

Door with burnished aluminium frame and
tempered transparent glass.

Finishes:

- extrabright glass
- bronzed glass
- mirror

Dimensions:

Heights (mm): 2265 - 2425 - 2585
Widths (mm): 478 - 586

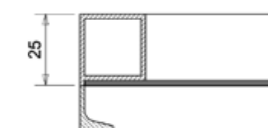
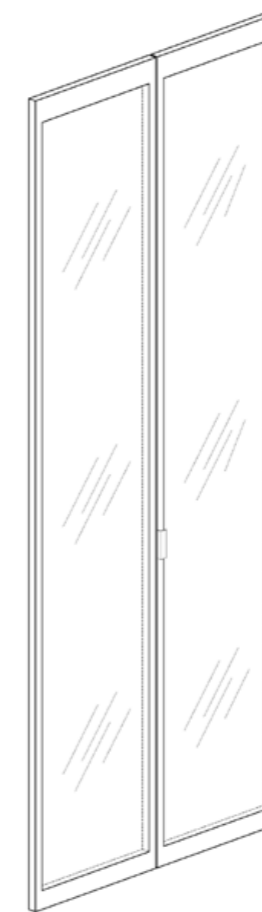



collection

WALK-IN CLOSET

Centopercento Cabina Armadio è per chi non vuole rinunciare ad un lusso sofisticato. Grazie ad un sottile sistema di cremagliere, è possibile comporre il proprio ambiente ricreando un lifestyle contemporaneo con soluzioni a misura.

Centopercento Walk-in Closet is for those who don't want to renounce to a sophisticated luxury. Thanks to a system of thin racks, it is possible to compose your own walk-in closet, reproducing a contemporary and customizable lifestyle.





Struttura in texwood antracite. Cassetti con frontali in pelle.

Structure and equipments in texwood anthracite. Drawers with leather front panels.







Centopercento Cabina Armadio con anta a specchio bronzato.

Centopercento Walk-in Closet with a shoes holder element with bronzed mirror door.







collection

TRAY

Linee rette e sporgenti distinguono la cassetiera Tray in essenza spazzolata colori.

Simple lines characterise Tray chest of drawers in colours lacquered brushed veneer.





collection

SCAPE

Pulizia e minimalismo nel design di Scape. | Cleanliness and minimalism highlight Scape design.





centopercento battente

ARMADI

MISURE TECNICHE | TECHNICAL DIMENSIONS

ALTEZZE | HEIGHTS

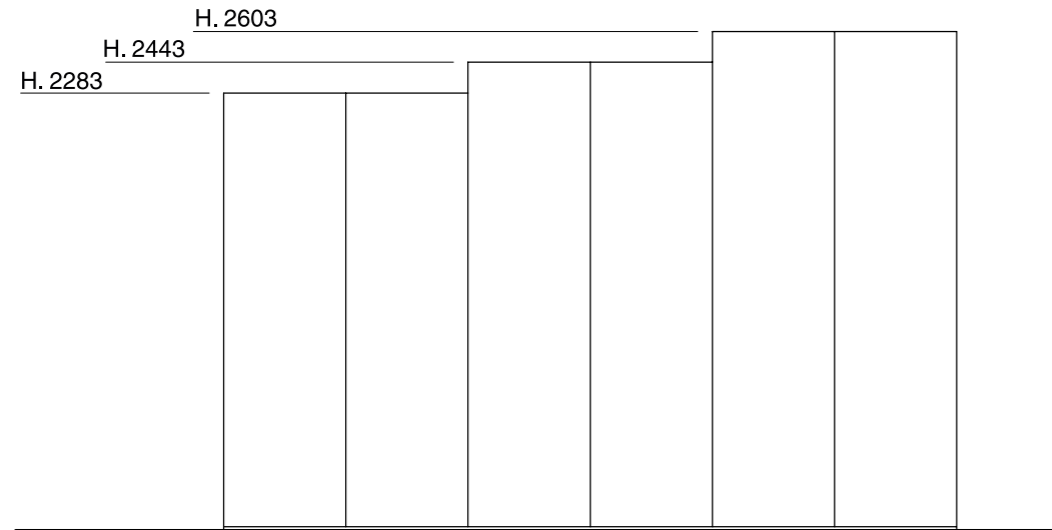

Per strutture con altezza superiore a 2603 mm ,
(altezza massima 2770 mm),
rivolgersi al nostro ufficio commerciale

Please contact us for the feasibility of wardrobe
structures taller than 2603 mm
(maximum height possible: 2770 mm).

LARGHEZZE / PROFONDITÀ | WIDTHS - DEPTHS

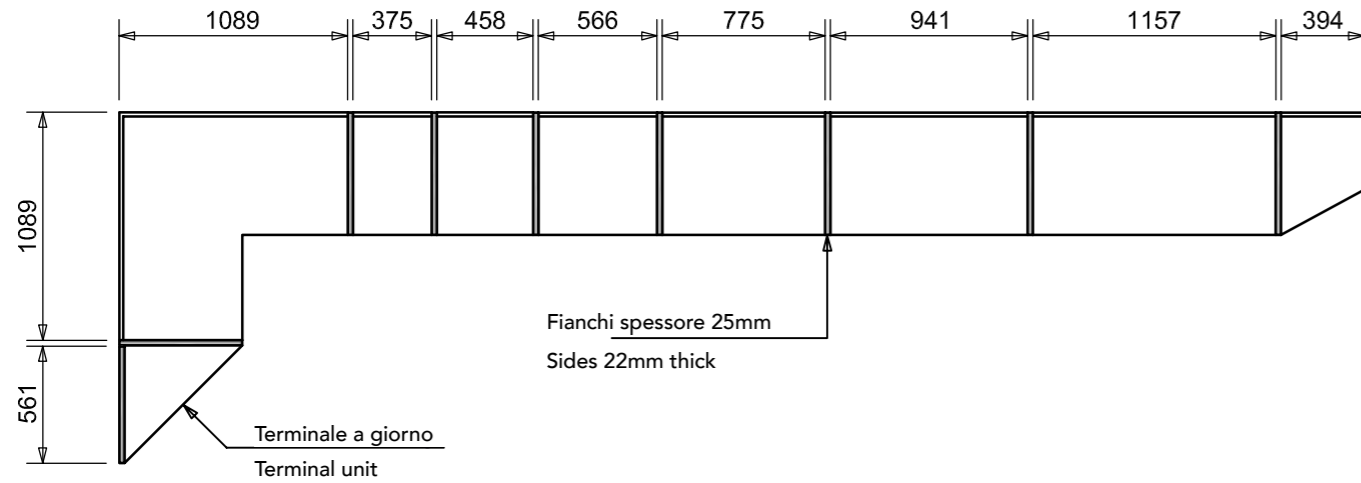

centopercento battente

ARMADI

MISURE TECNICHE | TECHNICAL DIMENSIONS

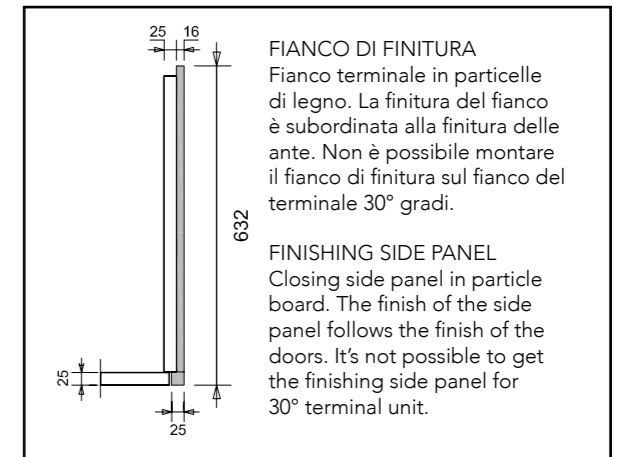
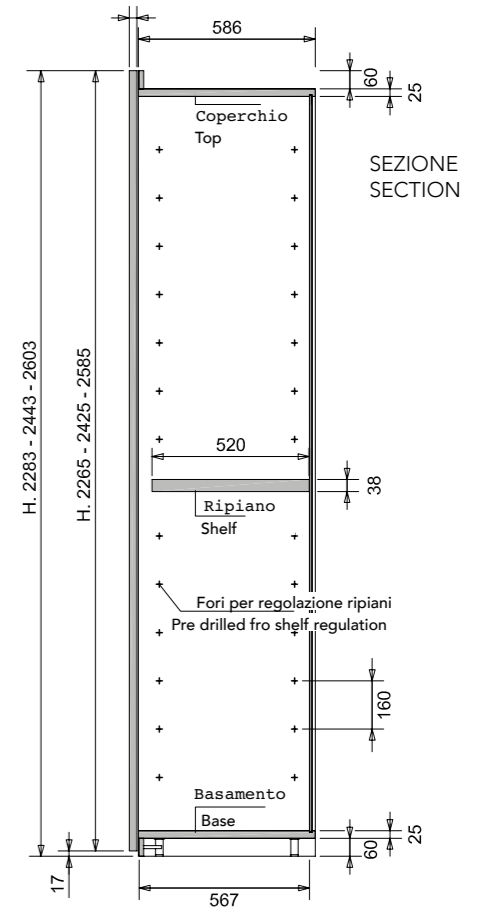
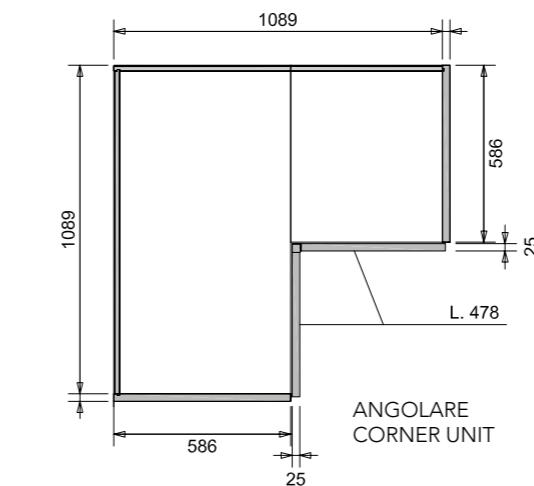
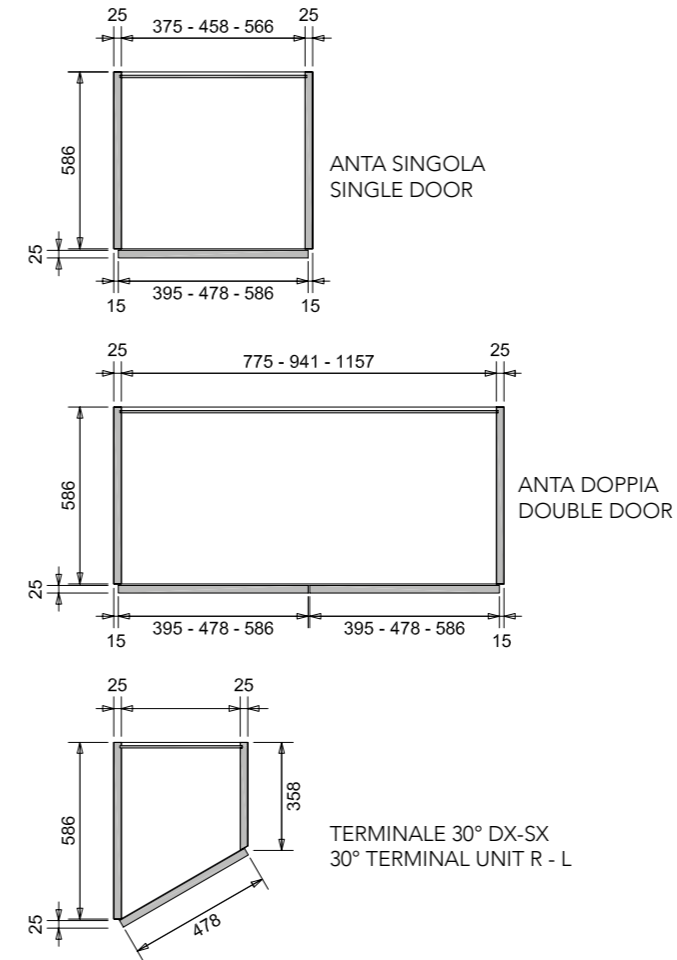

centopercento scorrevole

ARMADI

MISURE TECNICHE | TECHNICAL DIMENSIONS

ALTEZZE | HEIGHTS

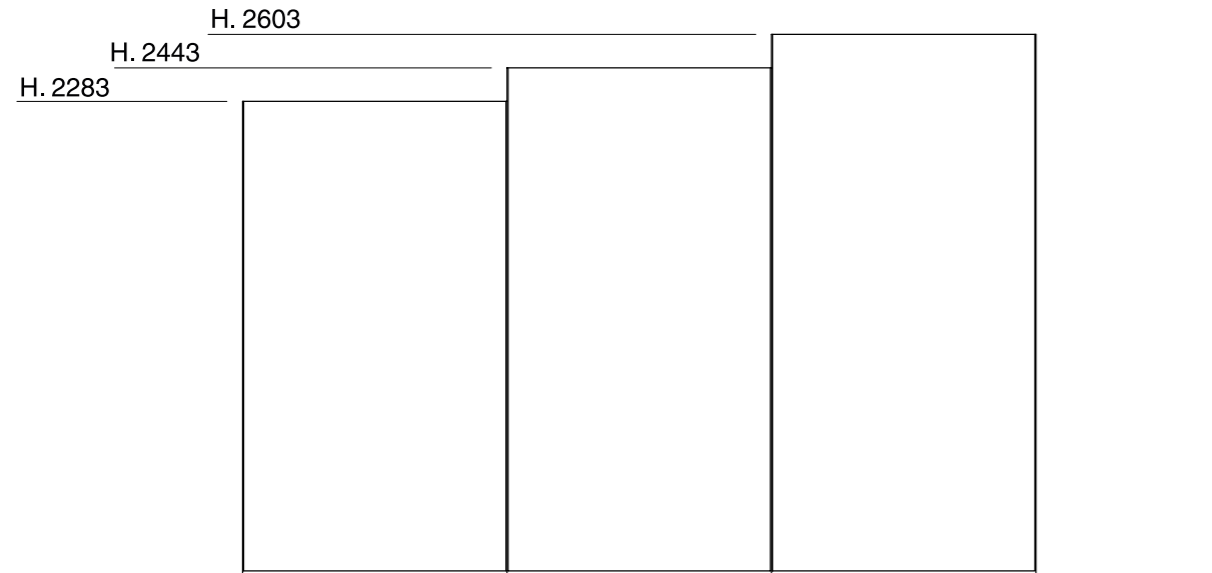

LARGHEZZE / PROFONDITÀ | WIDTHS - DEPTHS

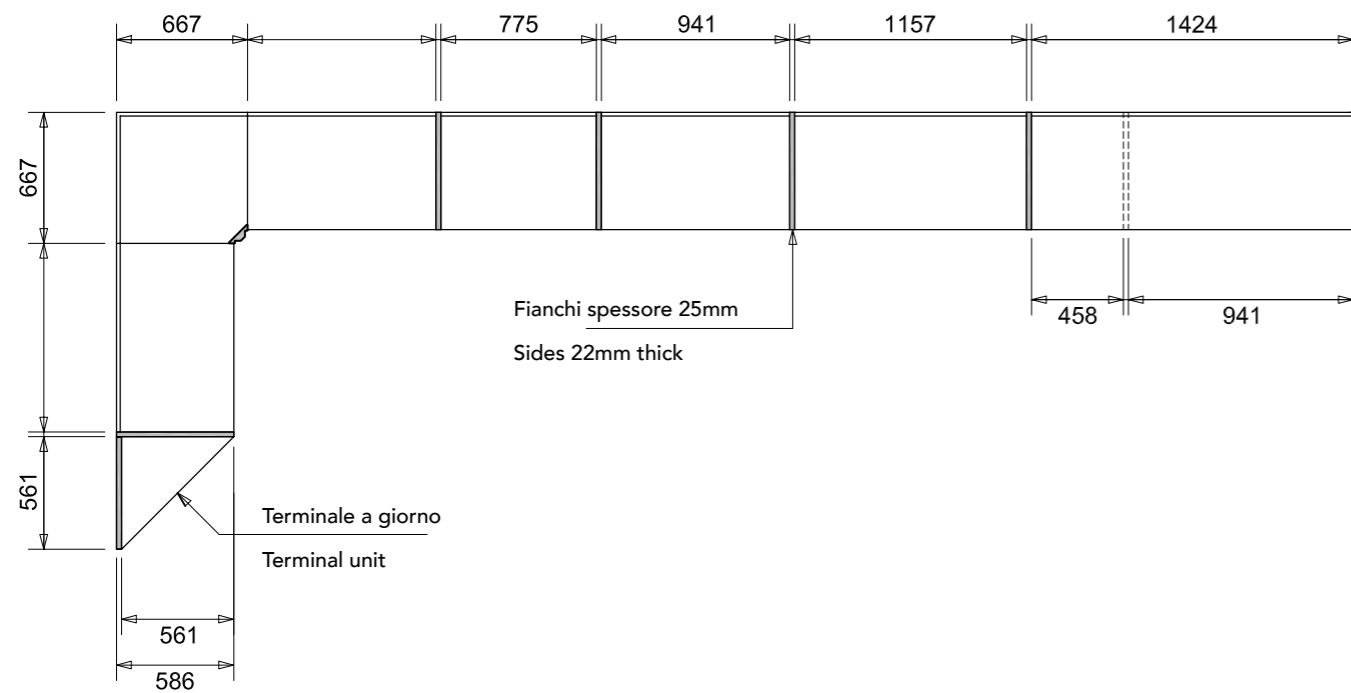

centopercento scorrevole

ARMADI

MISURE TECNICHE | TECHNICAL DIMENSIONS

PIANTE | PLANS

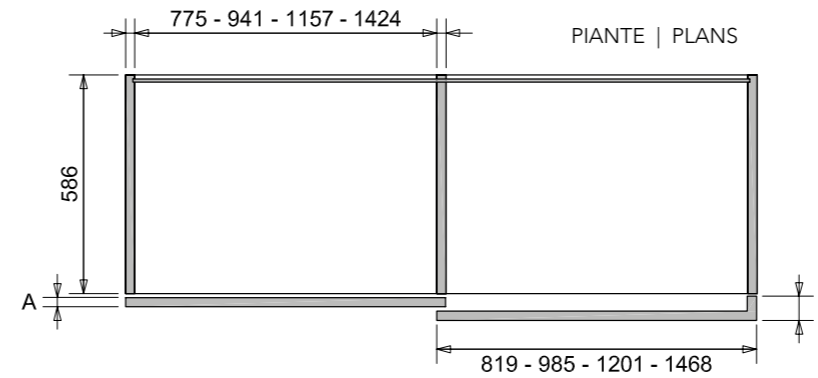

SEZIONE | SECTION

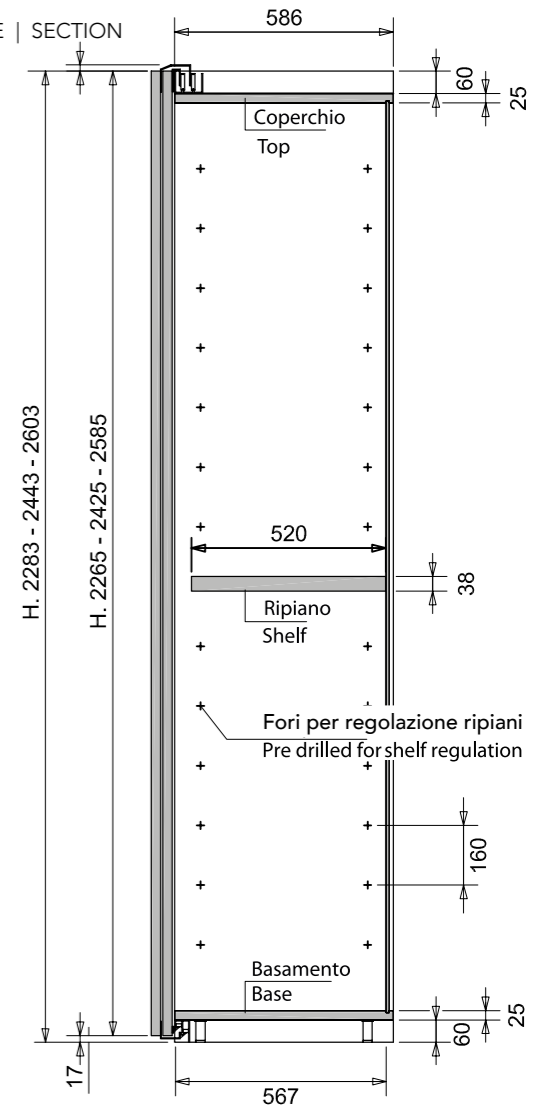

Tipologia Anta	A - Anta interna	B - Anta esterna
CLIDE	32 mm	71 mm
HIDE	29 mm	61 mm
MOSAICO	32 mm	71 mm
BAND	57 mm	116 mm
FLAP	57 mm	112 mm

Door type	A - Internal door	B - External door
CLIDE	32 mm	71 mm
HIDE	29 mm	61 mm
MOSAICO	32 mm	71 mm
BAND	57 mm	116 mm
FLAP	57 mm	112 mm

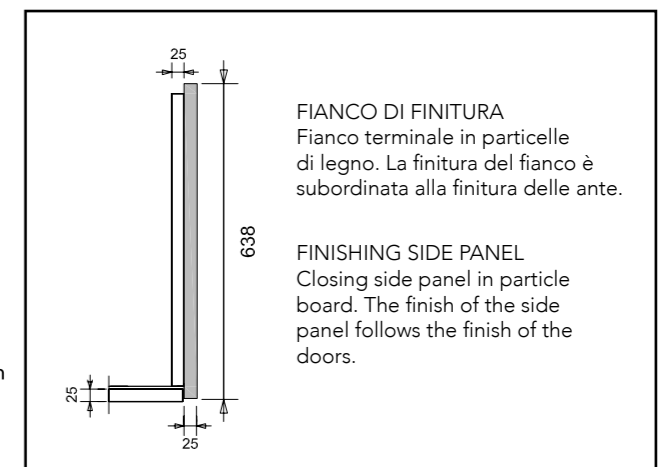
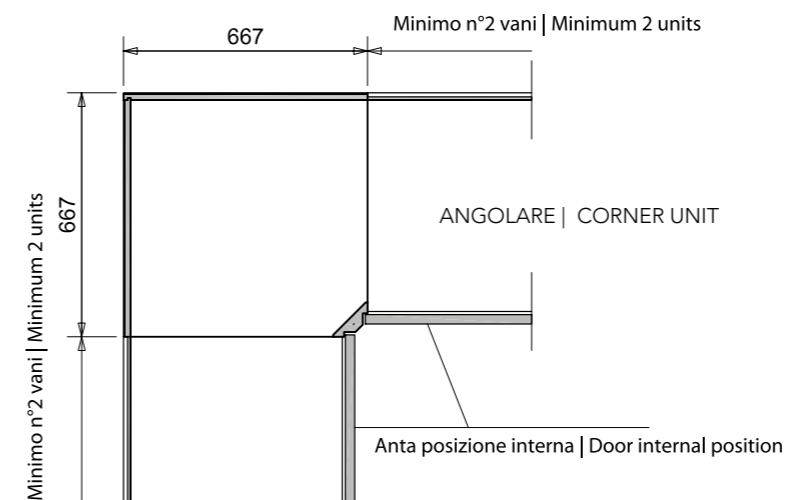

centopercento complanare

ARMADI

MISURE TECNICHE | TECHNICAL DIMENSIONS

ALTEZZE | HEIGHTS

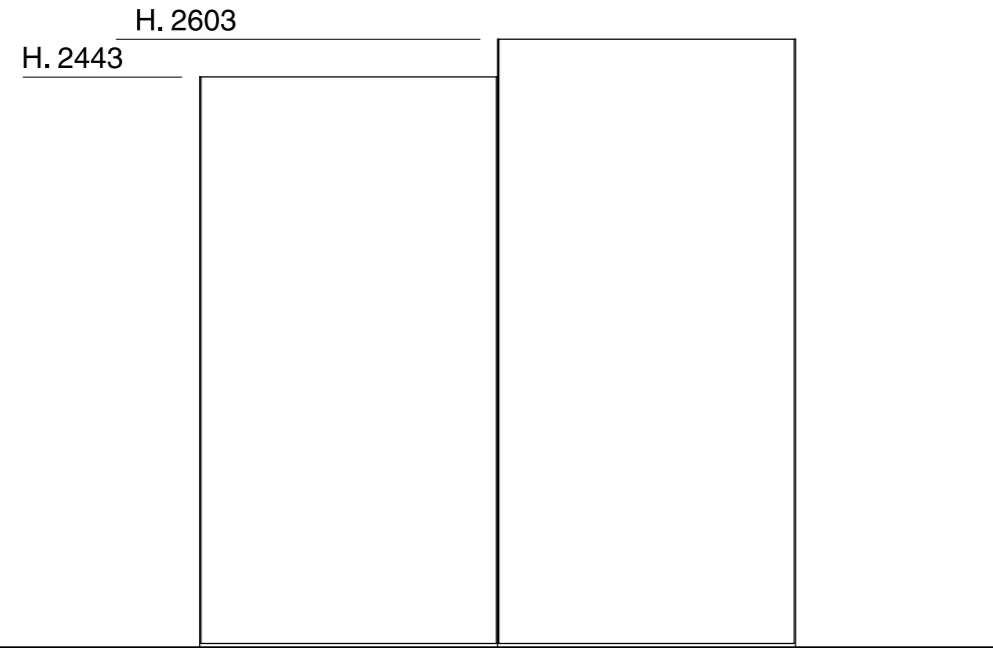

LARGHEZZE / PROFONDITÀ | WIDTHS - DEPTHS
 N.B. . Non sono possibili riduzioni in larghezza. | Notes: Cuts on size in width are not possible.

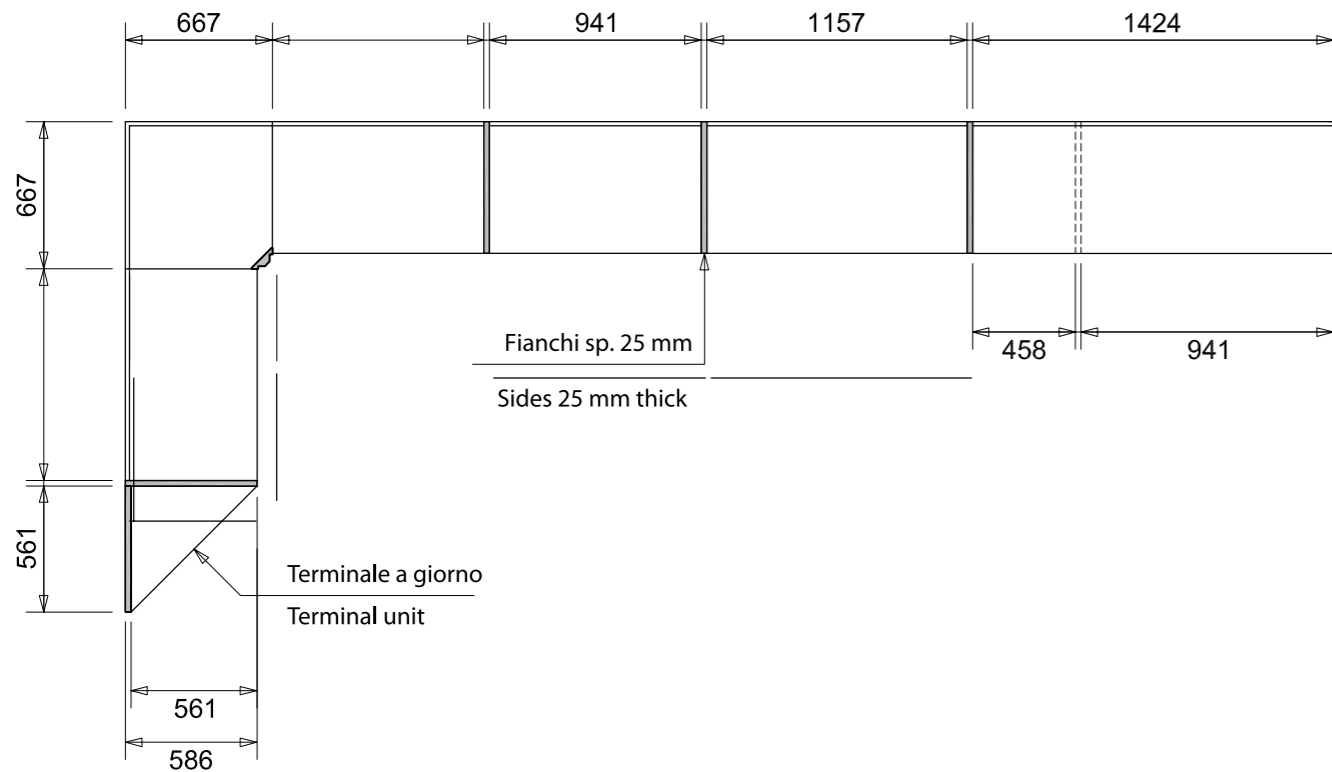

centopercento complanare

ARMADI

MISURE TECNICHE | TECHNICAL DIMENSIONS

PIANTE | PLANS

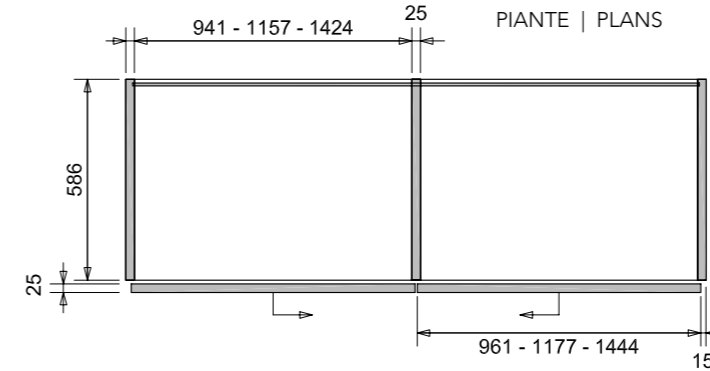

ANGOLARE | CORNER UNIT

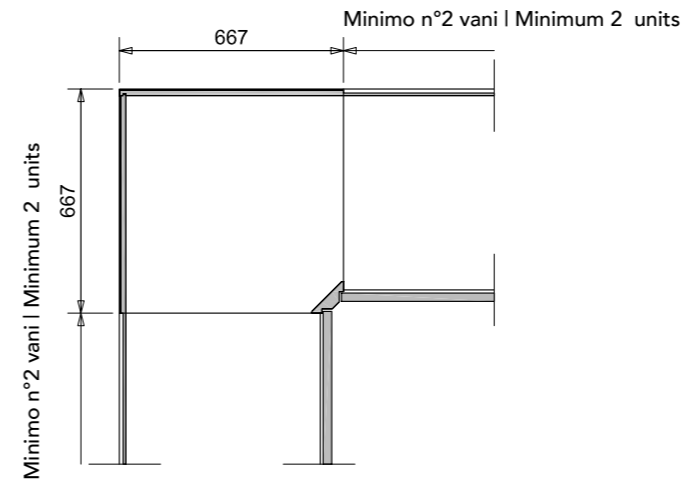

SEZIONE | SECTION

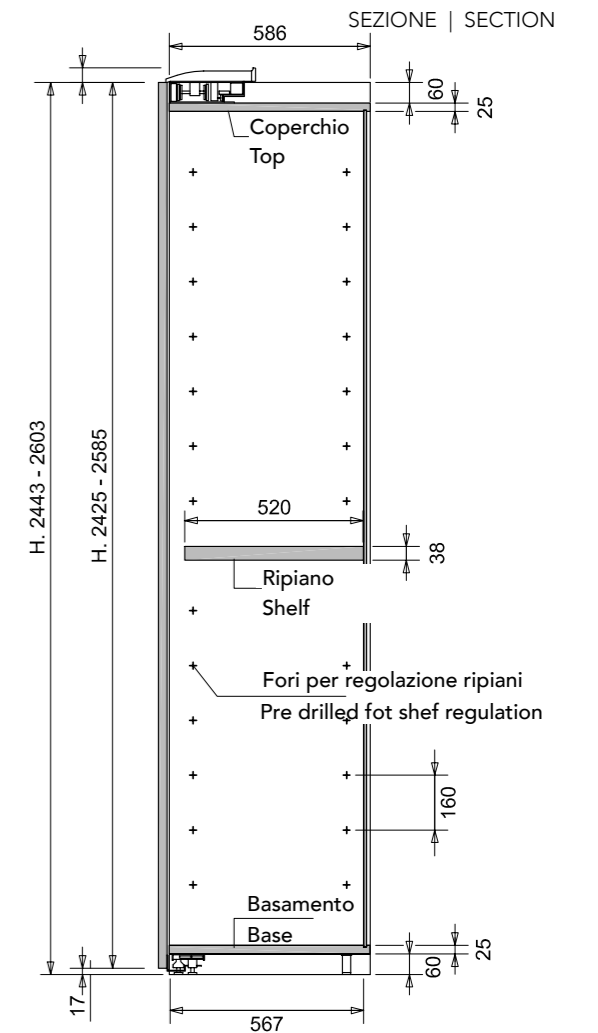

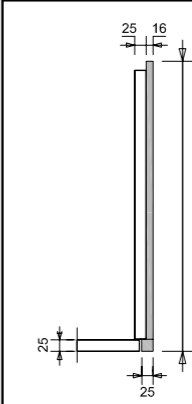

FIANCO DI FINITURA
 Fianco terminale in particelle di legno. La finitura del fianco è subordinata alla finitura delle ante. Non è possibile montare il fianco di finitura sul fianco del terminale 30° gradi.

FINISHING SIDE PANEL
 Closing side panel in particle board. The finish of the side panel follows the finish of the doors. It's not possible to get the finishing side panel for 30° terminal unit.

CENTOPERCENTO WALK-IN CLOSET

MISURE TECNICHE

TECHNICAL DIMENSIONS

Spazio utile necessario a soffitto (altezza): 10 mm.
Spazio utile necessario a parete (larghezza): 50 mm.

Please leave 10 mm space in height for assembly
Please leave 50 mm space in width for assembly

ALTEZZE

HEIGHTS

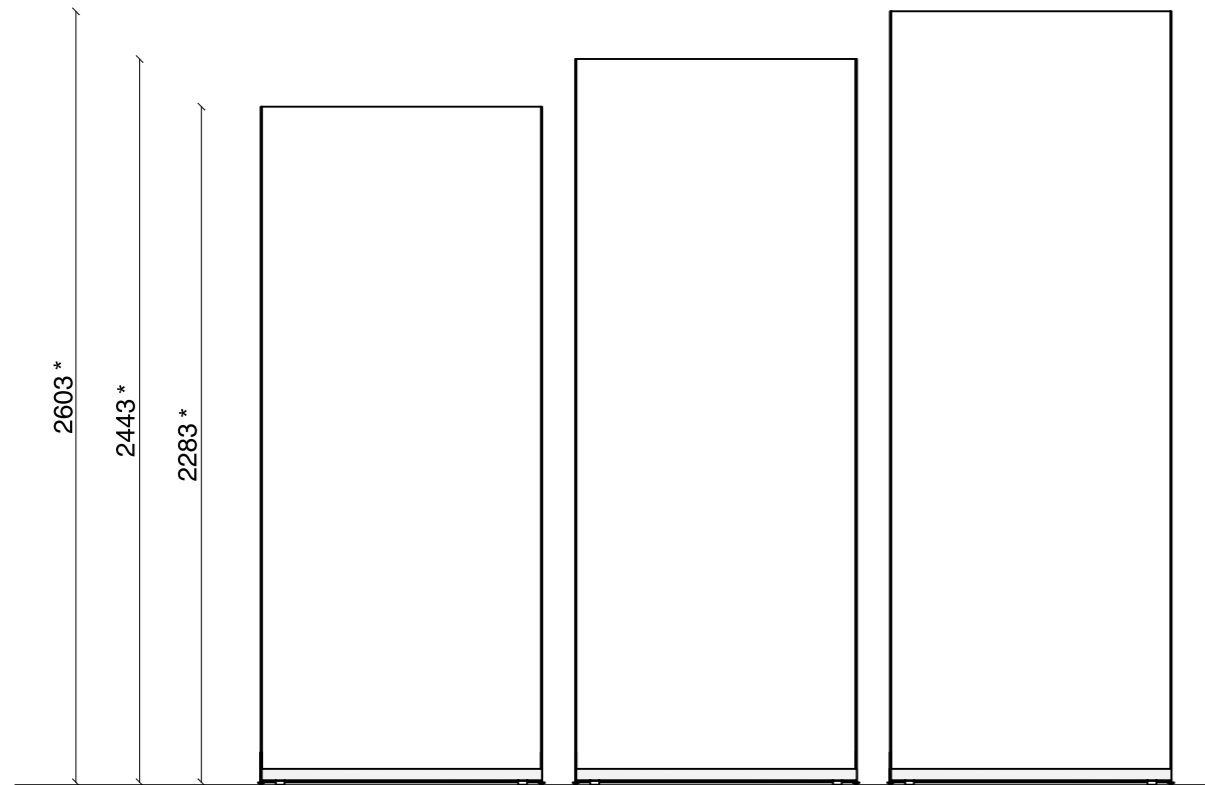

(*). Aggiungere H 7 mm per piedino | (*). Add 7 mm in height for feet

LARGHEZZE / PROFONDITÀ

WIDTHS / DEPTHS

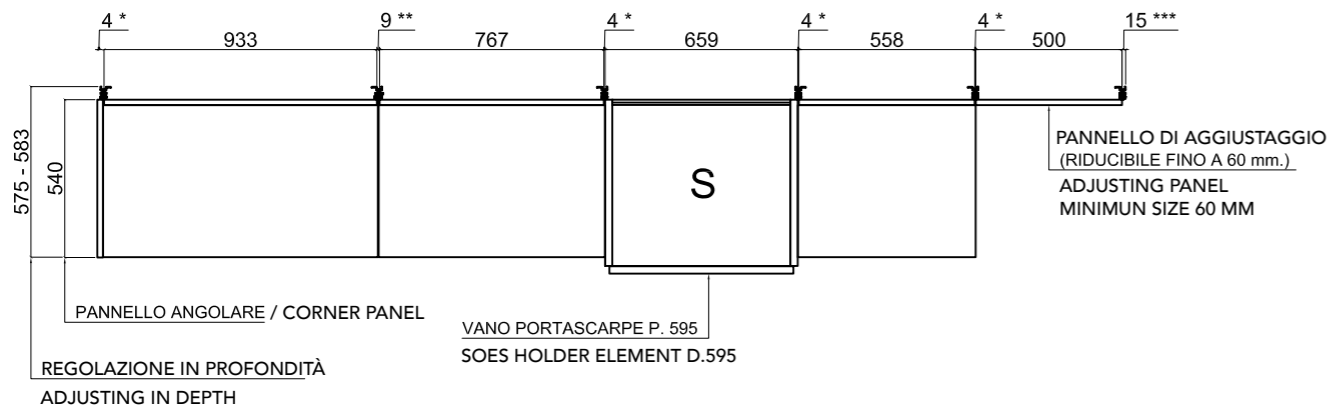

(*). Spazio tra moduli con cremagliera singola
(**) Spazio tra moduli con cremagliera doppia
(***) Ingombro cremagliera laterale

(*). Space between panels with single vertical rack
(**) Space between panels with double vertical rack
(***) Space for lateral vertical rack

CENTOPERCENTO WALK-IN CLOSET

MISURE TECNICHE

TECHNICAL DIMENSIONS

PIANTA

PLAN

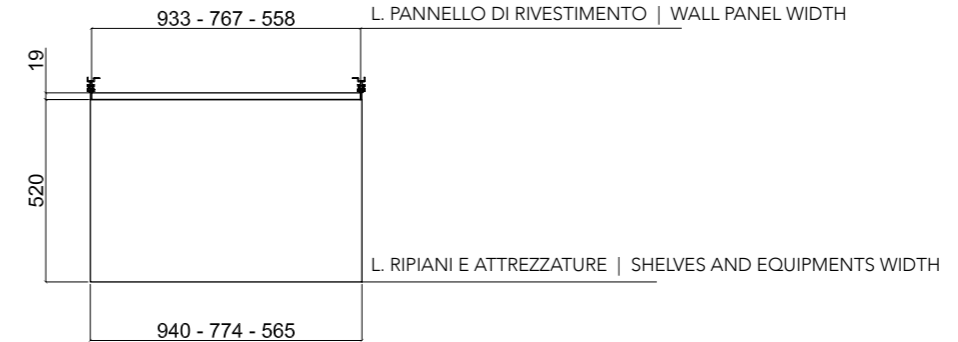

POSSIBILITA' DI COMBINAZIONE MODULO ANGOLARE
I moduli angolari sono composti dai moduli di serie L.933 e L.767, più il pannello angolare L.540.

EXAMPLES OF COMBINATION FOR CORNER MODULES
The corner modules are composed of standard modules W.933 and W.767 plus the corner panel W.540

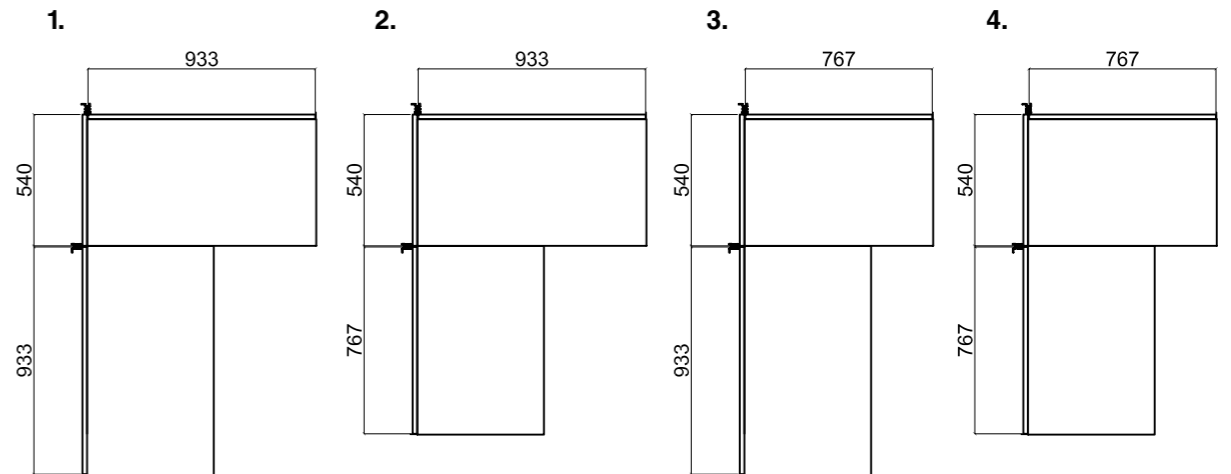

PROFILI DI CHIUSURA

A : profilo terminale L.60, spessore 19 (chiusura a muro).
B : profilo terminale angolare 60 x 60, spessore 19 (chiusura a vista).

CLOSING PROFILES

A : terminal profile W.60, 19 mm thick (closing on a wall).
B : terminal profile 60x60, 19 mm thick (closing at sight).

PROFILI A CREMAGLIERA

C : profilo verticale singolo, si utilizza quando non va affiancata l'attrezzatura tra i moduli adiacenti.
D : profilo verticale doppio, si utilizza quando vanno affiancati due ripiani o attrezzature tra i moduli adiacenti.

VERTICAL RACK PROFILES

C : single vertical profile, it is used when there is no equipment placed side by side on the adjacent panels.
D : double vertical profile, it is used when two shelves or equipments are placed side by side on adjacent panels.

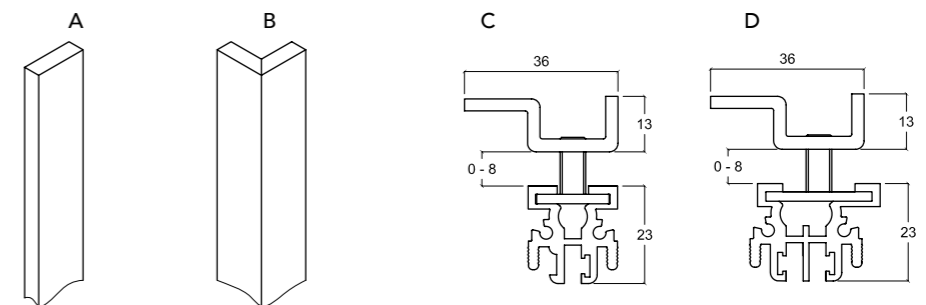

ELAM SYSTEM s.r.l.
ITALIA
via Pietro Mascagni, 56/58
22066 - Mariano Comense (CO) Italy
T. +39 031 355 18 60
F. +39 031 355 18 38

UNITED KINGDOM
83/85, Wigmore Street
W1U 1DL London UK
T.+44 020 7491 2044

Art direction:
Ag.Santi&Santi
Milano

Graphic:
Ag.Santi&Santi

Photo:
Andrea Martiradonna
Beppe Raso

Print:
Grafiche Boffi

tisettanta.com

