



CINQUEPUNTOZERO

5.0 / SPAZIO_NOTTE

Il programma armadi Spazio Notte, è un progetto del contenere che offre massima flessibilità: di dimensioni prima di tutto, ma anche di materiali, elementi, finiture, accessori, attrezzature.

Il concetto si sviluppa intorno all'eccezionale varietà di ante battenti e scorrevoli, e all'assoluta libertà compositiva delle cabine armadio per le quali, oltre al sistema classico a cremagliera "Wall", propone il sistema con montanti metallici "Eureka" ed il sistema autoportante "Side", che consentono di ridefinire ed organizzare al meglio gli ambienti.

Massima personalizzazione anche per le attrezzature interne, che completano la proposta di un progetto trasversale, che si presta così ad arredare i diversi spazi del vivere quotidiano.

5.0 / NIGHT_SPACE

The Spazio Notte wardrobe programme is a storage project that provides maximum flexibility: of dimensions primarily, but also materials, elements, finishes, accessories and fittings.

The concept develops around an exceptional variety of hinged and sliding doors and complete freedom to compose walk-in closets, with a classical 'Wall' rack system, the 'Eureka' system with metal uprights, and 'Side', a self-supporting system with which to redefine and organise rooms.

Great customisation opportunities are also provided by the internal fittings, which complete a cross-over project to furnish different areas in the home.

ARMADI ANTA BATTENTE
HINGED DOOR WARDROBES

Anta Free Free door	p. 30, 42, 50, 56, 62, 76
Anta Go Go door	p. 16
Anta Gola Gola door	p. 8, 24, 36
Anta Linea Linea door	p. 68

ARMADI ANTA SCORREVOLE
SLIDING DOOR WARDROBES

Anta Cross Cross door	p. 92
Anta Dama Dama door	p. 108
Anta Decor 1 Decor 1 door	p. 142
Anta Fascia Fascia door	p. 124
Anta Fascia Grafica Fascia Grafica door	p. 130
Anta Free 25 Free 25 door	p. 116
Anta Go 25 Go 25 door	p. 102
Anta Gola 25 Gola 25 door	p. 134
Anta Specchio Specchio door	p. 154
Anta Terry Terry door	p. 84
Anta Tetris Tetris door	p. 92

CABINE ARMADIO
WALK-IN CLOSETS

Eureka	p. 154, 174
Side	p. 160
Wall	p. 142, 168
Sistema Scorrevole Slide Show Slide Show sliding system	p. 62, 142, 160, 168

CONTENITORI
STORAGE UNIT

Full Dream	p. 8, 102
Top Trend	p. 30
Full Trend	p. 42
Full Tweet	p. 24, 84
Full Vip	p. 108, 160
Comodino Rast Rast bedside table	p. 8
Tetris	p. 134, 142
Tray	p. 92, 116

SISTEMA LETTI
BED SETS

Air	p. 8
City	p. 42, 124
Cube Legno	p. 84
Cube Legno inserto imbottito Cube Legno padded insert	p. 160
Elegance	p. 142
Flo	p. 108
Line	p. 24
Street	p. 30
Time	p. 116
Togo	p. 92
Tomorrow	p. 102

DATI TECNICI
TECHNICAL DATA

Armadi ante battenti Hinged doors wardrobes	p. 182
Armadi ante scorrevoli Sliding doors wardrobes	p. 184
Accessori interni armadi Internal wardrobe accessories	p. 189
Maniglie armadi Wardrobe handles	p. 194
Contenitori e maniglie Storage units and handles	p. 197
Sistema letti Bed sets	p. 204
Finiture Finishes	p. 208

ARMADI ANTA BATTENTE
HINGED DOOR WARDROBES

Anta Free p. 30, 42, 50, 56, 62, 76
Free door

Anta Go p. 16
Go door

Anta Gola p. 8, 24, 36
Gola door

Anta Linea p. 68
Linea door

OI

Gola hinged door
Full Dream unit
Rast bedside table
Air bed

MODERN, ELEGANT AND CUSTOMISED

modernità, eleganza e personalizzazione









Il letto Air è caratterizzato da un pannello boiserie a parete, con luci led a richiesta e corredato dal comodino Rast con mensole in metallo; inoltre può avere la base con contenitore e rete sollevabile.

The Air bed features a wall boiserie panel with LED lighting if required, complete with Rast bedside table with metal shelves; may also be provided with a storage compartment in the base and lift-up bed base.



02

Go hinged door

ESSENTIAL, HARMONIOUS AND TRANSPARENT

essenzialità, armonia e trasparenza







Anta minimale che si caratterizza per il profilo a "mezza" gola che crea un disegno essenziale sull'anta. Disponibile in alluminio, laccata in tutti i colori.

Minimal door featuring a 'half' grip profile that creates a clean-cut pattern on the door. Available in aluminium or lacquered in any colour.





Per il sistema libreria, sono disponibili anche ante Smart con vetro Stop Sol e telaio in alluminio brunito Metal Grey con maniglia verticale laterale; mensole retroilluminate con luce led.

The bookcase system can also be provided with Smart doors incorporating Stop Sol glass and a Metal Grey burnished aluminium frame, vertical handle on the side, and backlit shelves with LED lights.



03

Gola hinged door
Full Tweet unit
Line bed

**MODERN,
ELEGANT
AND
DESIGN**

modernità, eleganza e disegno

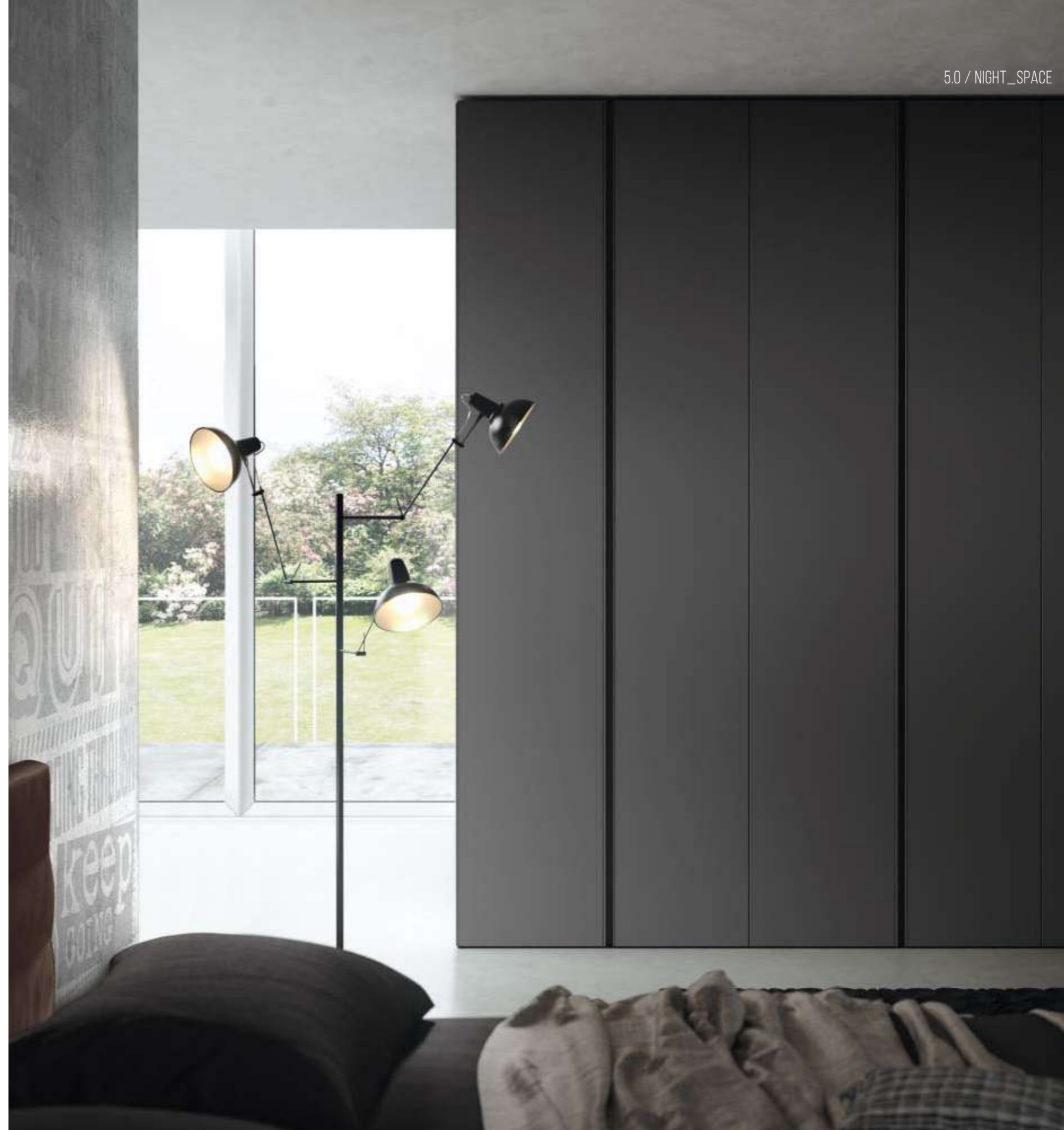





I contenitori Full Tweet si distinguono per il particolare sistema di apertura con gola, che oltre ad essere elemento funzionale, diventa parte caratterizzante dell'estetica.

Full Tweet storage units are distinguished by a special opening system with grip profile, which is an aesthetic feature as well as a practical solution.



04

Free hinged door
Top Trend unit
Street bed

MATERIALS, CONTRASTS AND BALANCE

materia, contrasto ed equilibrio







Il gioco di spessori e materiali disegna la testiera del letto Street con giroletto Right. Disponibile nelle finiture Bianco Alaska, Olmo Bianco, Perla, Grigio Seta, Lava, Olmo Cotto, Rovere Nodato Scuro, Rovere Nodato Miele. Il gruppo Top Trend è presentato con maniglia T1.

Thicknesses and materials create an interesting effect for the Street headboard with Right bed frame. Available with the following finishes: Bianco Alaska, Olmo Bianco, Perla, Grigio Seta, Lava, Olmo Cotto, Rovere Nodato Scuro, and Rovere Nodato Miele. The Full Tweet unit has a T1 handle.



05

Gola hinged door

**LUMINOUS,
WELL-
BALANCED
AND
DECORATIVE**

luminosità, equilibrio e decoro







L'anta Gola è contraddistinta da un profilo minimale a tutta altezza, in alluminio laccato in tutti i colori. Nell'elemento personalizzabile, si abbina all'anta Free che è proposta con stampa digitale di una delle sei grafiche disponibili di serie. La stampa è fattibile solo sulle ante Free L 298 mm.

The Gola door comes with a minimal, full-length profile in aluminium lacquered in any colour. The customisable element has a Free door with one of our standard digital printed patterns. Printing on L 298 mm Free doors only.



06

Free hinged door
Full Trend unit
City bed

ESSENTIAL LINES, TEXTURE AND COLOUR

essenzialità, matericità e colore

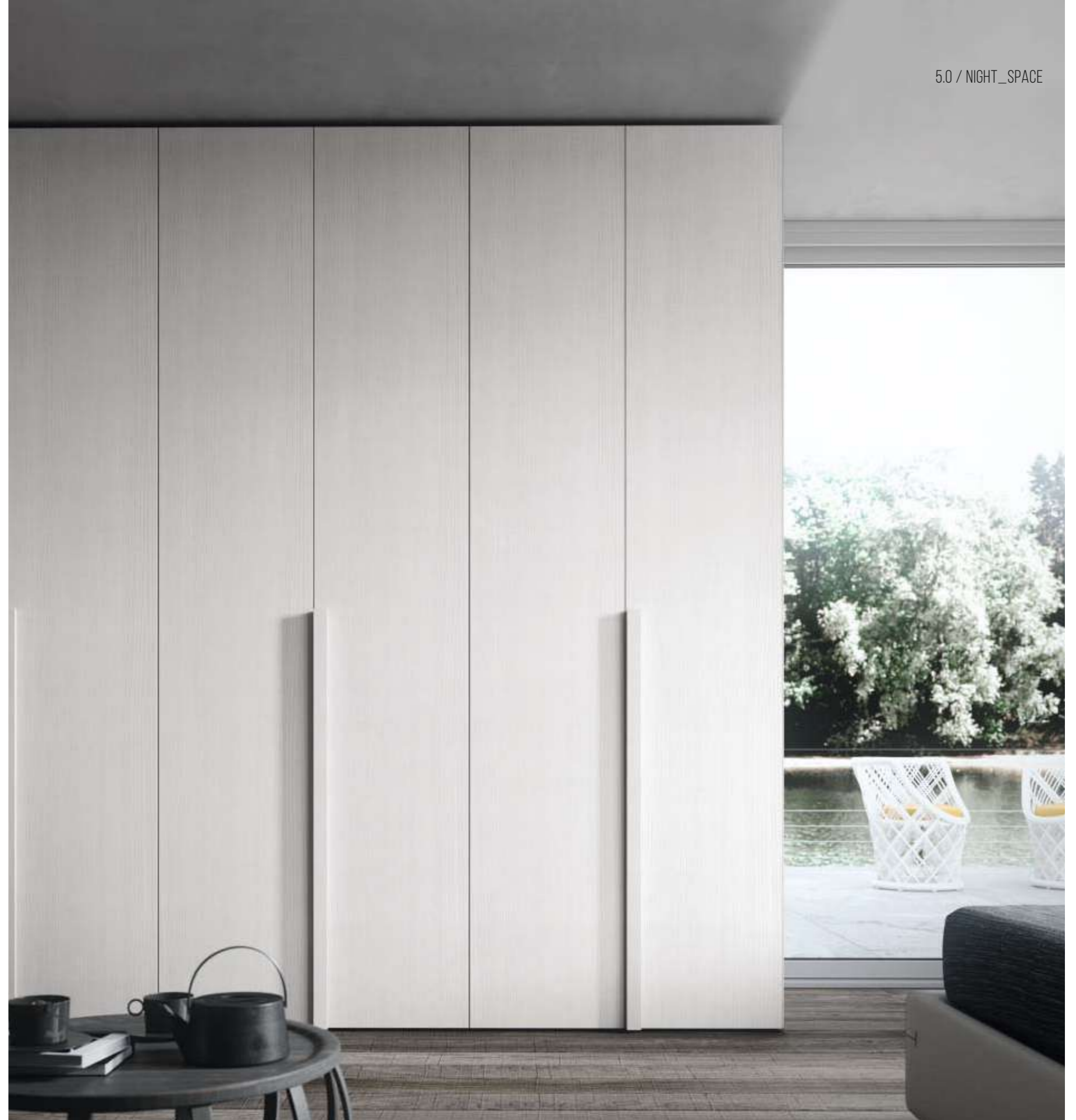







07

Free hinged door

**REFINED,
ORDERLY
AND
QUIET**

raffinatezza, ordine e quiete





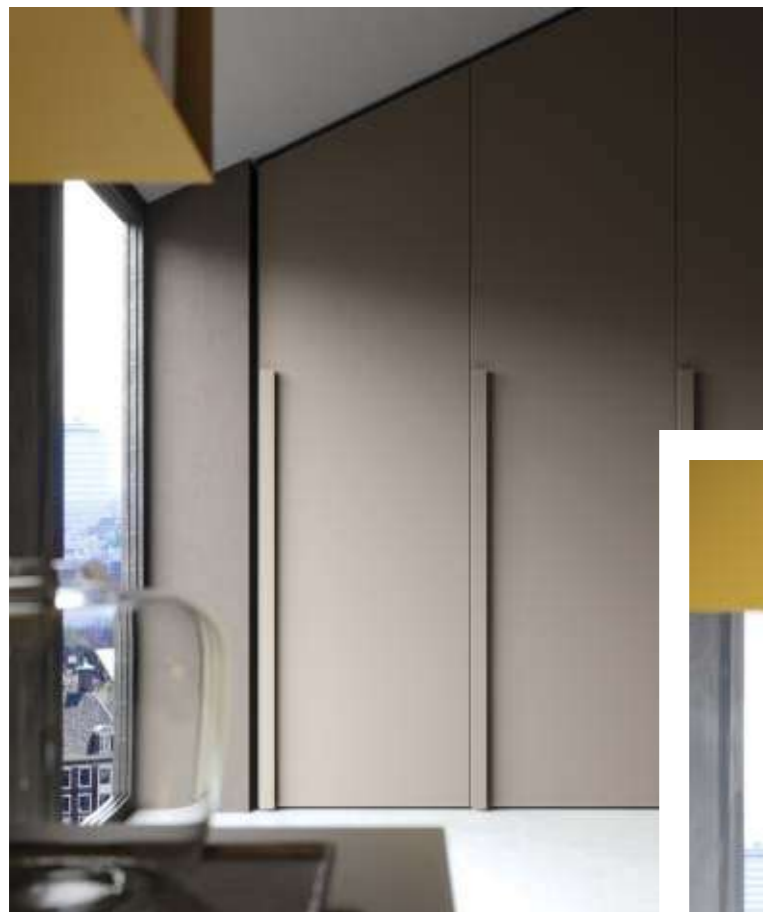

L'ampia modularità degli armadi e la possibilità di avere tagli a misura, garantisce soluzioni funzionali per ogni esigenza e tipologia di spazio.
L'anta Free è presentata con maniglia X1.

The range of wardrobe modules and the possibility to cut to size provides functional solutions for all needs and space.
Free door with X1 handle.



08

Free hinged door

**SOBRIETY,
CHARACTER
AND
CUSTOMISATION**

sobrietà, carattere e personalizzazione

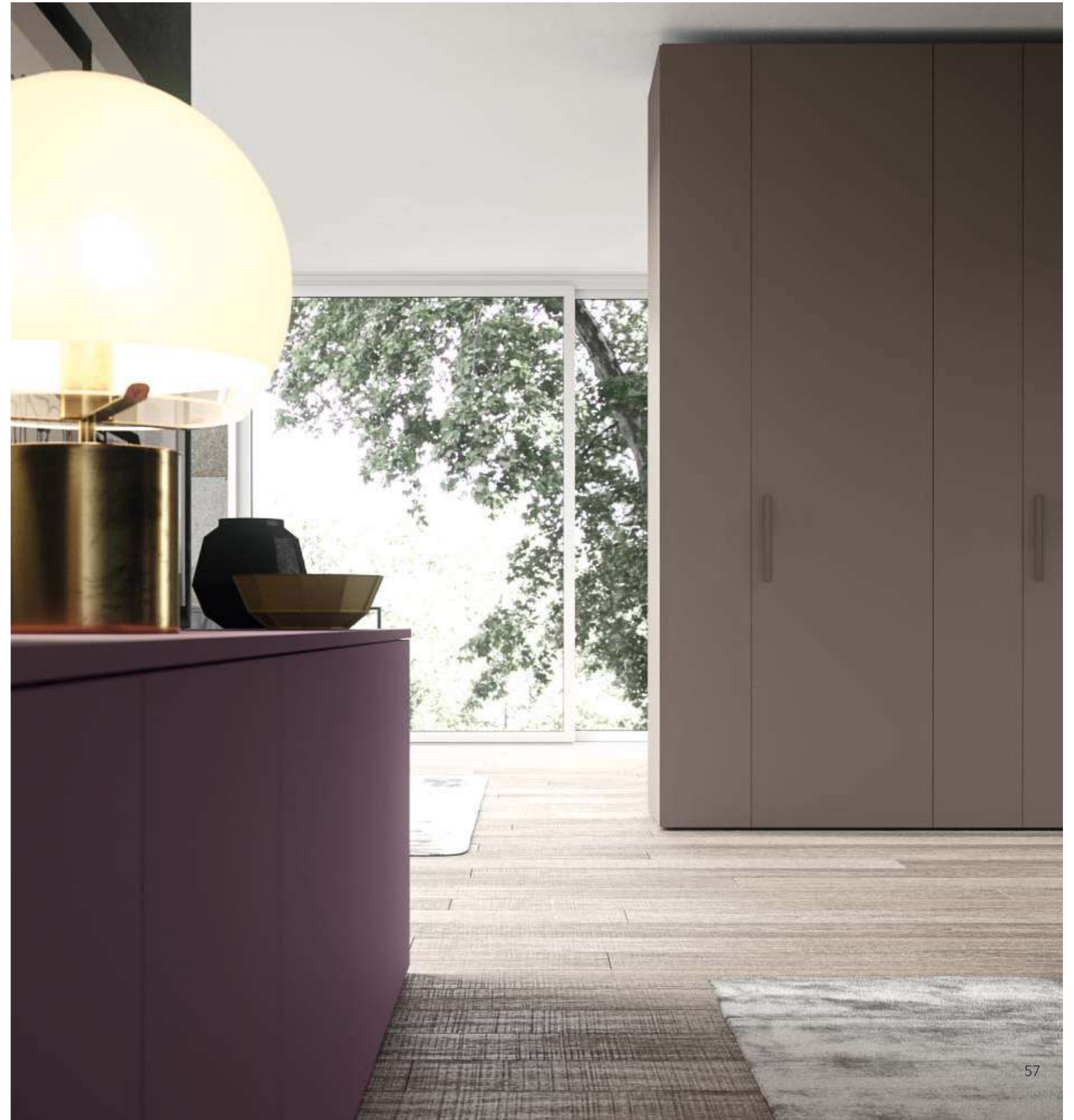





Un modulo personalizzabile per creare un effetto di piacevole asimmetria, dove l'anta da 298 mm è abbinata all'anta da 598 mm, così da rompere il rigore dell'armadio con anta liscia. Oltre alle finiture in melaminico, materico e laccato opaco, per questo elemento è possibile avere le ante L 298 mm in vetro laccato o Laminam®, oppure stampate in digitale con una delle sei grafiche disponibili a catalogo. L'anta Free è presentata con maniglia Stilo di serie.

A customisable module with which to create a pleasant, asymmetrical effect, with a 598 mm door is coupled with a 298 mm one to give movement to a wardrobe with a plain door. Besides melamine, textured and matt lacquered finishes, this element can also be provided with a L 298 mm door lacquered glass or Laminam®, or with one of our six digital printed patterns. Free door with standard Stilo handle.



09

Free hinged door
Slide Show sliding system

MINIMALISM, ORDER AND TRANSPARENCY

minimalismo, ordine e trasparenza







Sia il modulo terminale dritto che il modulo ad angolo, possono essere accessoriati con ripiani o tubi appendiabiti. Sono inoltre disponibili dei sistemi di illuminazione led, che possono andare installati sul coperchio o sul fianco dell'armadio. L'anta Free è presentata con maniglia Mood.

Both the straight end module and the corner module can be fitted with shelves or clothes hanger rods. LED illumination is also available to install on the cabinet top cover or side panel. Free door with Mood handle.

IO

Linea hinged door

HARMONY, GOOD LOOKS AND ORDER

armonia, estetica e ordine





Al nostro sistema di armadi possono essere abbinati dei moduli libreria del programma Living Space, per creare delle soluzioni di arredo trasversali, adatte anche per l'arredo della zona giorno, studio o spogliatoio.

Our wardrobe systems can be matched with Living Space bookcase modules to create decor that crosses over into the living room, study or closet.





L'interno di ogni armadio, può essere organizzato con una numerosa gamma di accessori fra cui portapantaloni e vaschette estraibili libere, per ogni tipo di oggetto.

Every wardrobe can be organised inside with a wide range of accessories, including pull-out trouser trays and left free trays to take any type of object.



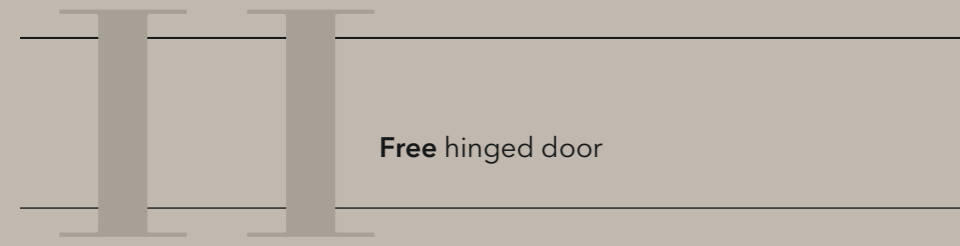

Free hinged door

ELEGANCE, SIMPLICITY AND BALANCE

eleganza, semplicità ed equilibrio

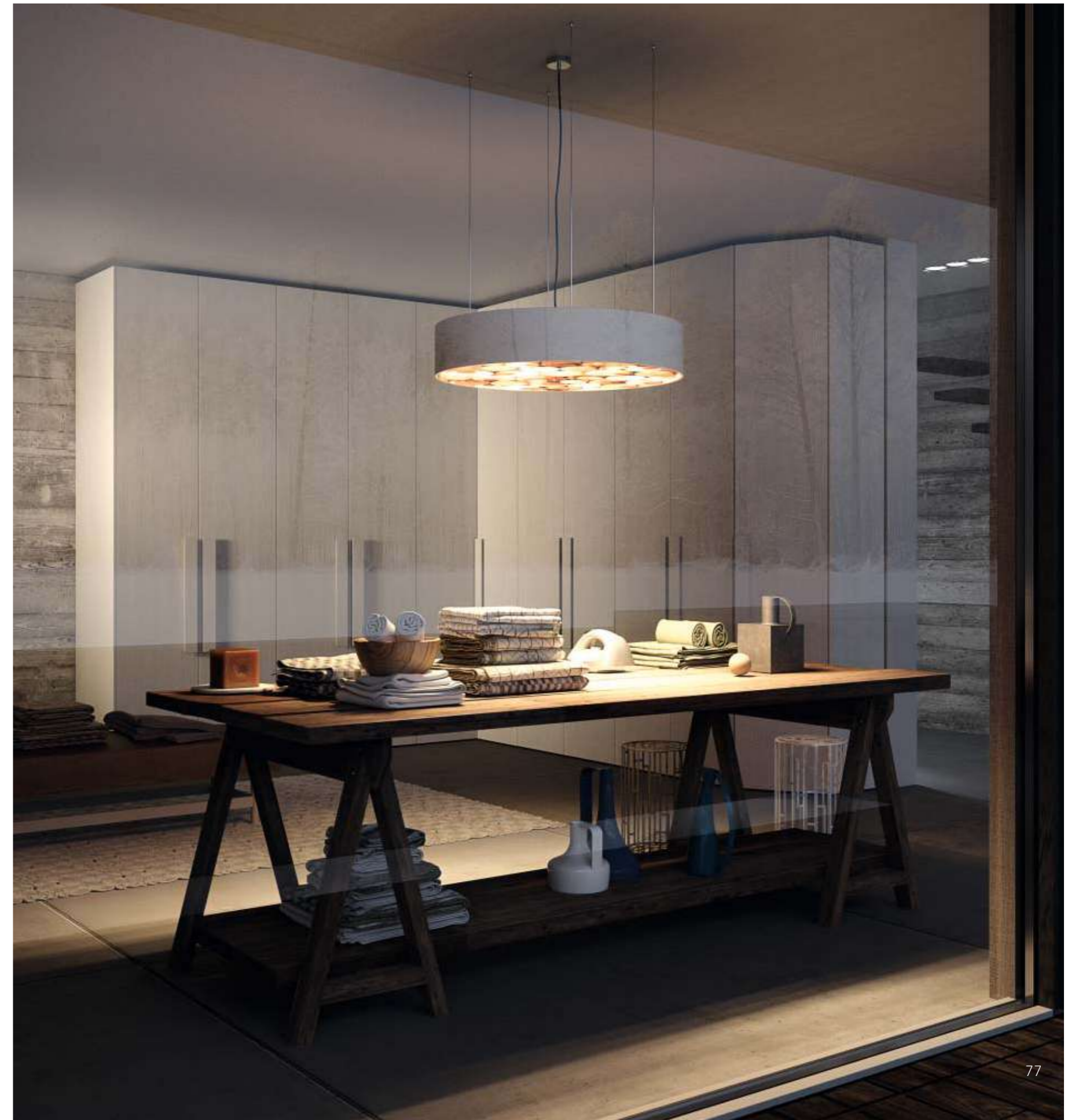





Ogni elemento contenitore può essere personalizzato grazie ad un'ampia scelta di attrezzature interne, funzionali e curate nel dettaglio. L'anta Free è presentata con maniglia T2.

Each storage element can be customised with a wide range of beautifully detailed, functional internal fittings. Free door with T2 handle.

ARMADI ANTA SCORREVOLE
SLIDING DOOR WARDROBES

Anta Cross p. 92
Cross door

Anta Dama p. 108
Dama door

Anta Decor 1 p. 142
Decor 1 door

Anta Fascia p. 124
Fascia door

Anta Fascia Grafica p. 130
Fascia Grafica door

Anta Free 25 p. 116
Free 25 door

Anta Go 25 p. 102
Go 25 door

Anta Gola 25 p. 134
Gola 25 door

Anta Specchio p. 154
Specchio door

Anta Terry p. 84
Terry door

Anta Tetris p. 92
Tetris door

OI

Terry sliding door
Full Tweet unit
Cube Legno bed

**ELEGANCE,
EFFECT
AND
TEXTURE**

eleganza, gioco e materia

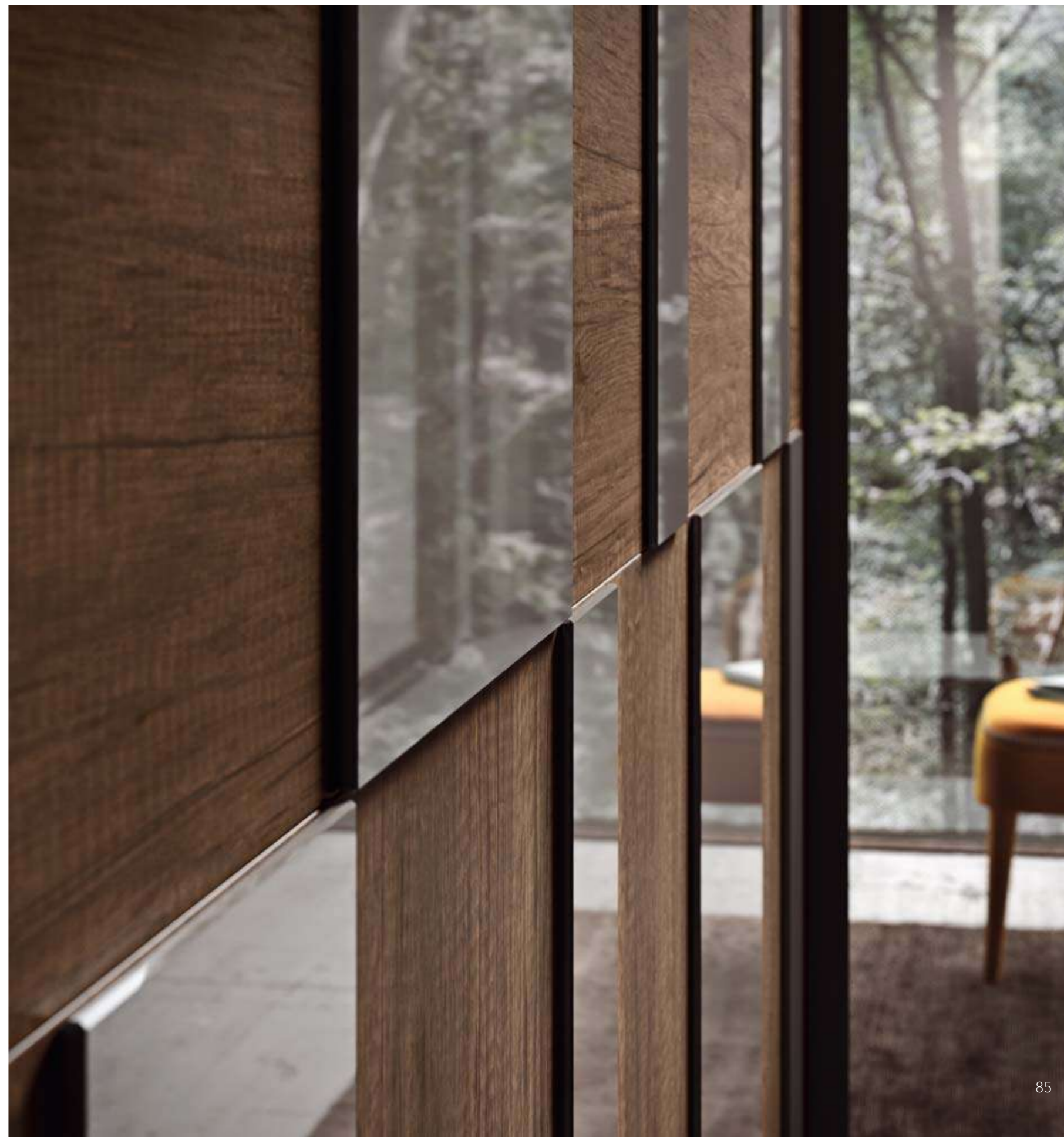







Una testiera che gioca con pannelli dagli spessori diversi, la possibilità di abbinare texture materiche a finiture laccate, un sottile giroletto su piedino, sono gli elementi che definiscono il letto Cube Legno.

A headboard that juggles panels of different thicknesses, the possibility to match textures with lacquered finishes, and a slim bed frame on legs are the distinguishing features of the Cube Legno bed.



02

Tetris / Cross sliding door
Tray unit
Togo bed

SHAPE, ELEGANCE AND DESIGN

forma, eleganza e disegno







Il comò Tray è qui presentato con ripiano in vetro laccato, perfettamente abbinato al particolare gioco di vetri che distingue l'anta Tetris; gli inserti dell'anta Tetris sono disponibili in vetro laccato e in specchio.

A minimal door that can be dressed up with different handles: the impressive, contemporary Oviedo one is shown here. A new way to give a personal and distinctive touch to any night. A minimalist personality skilfully paired with contemporary details.





Estetica all'insegna della leggerezza per il letto Togo, grazie al particolare giroletto con rete strutturale, sostenuto da piedini trasparenti e caratterizzato da una testiera con doppia cuscinatura imbottita. Disponibile con rivestimento in microfibra o tessuto e profilo "a coda di topo" con colore personalizzabile.

Airy good looks for the Togo bed with its special bed frame incorporating a base standing on transparent legs and featuring a headboard with double padded cushions. Available upholstered in microfibre or fabric with piped trim in a colour of the customer's choice.





03

Go 25 sliding door
Full Dream unit
Tomorrow bed

**BALANCE,
ORDER
AND
CLEAN-CUTLINES**

equilibrio, ordine e pulizia







04

Dama sliding door
Full Vip unit
Flo bed

TEXTURE, STYLE AND HARMONY

materia, stile ed armonia







Estetica all'insegna della raffinatezza per i contenitori Full Vip, dove i volumi essenziali in legno, sono impreziositi dall'insero in laccato che funge anche da presa.

Refined good looks for Full Vip storage units, where the essential parts in wood are enhanced by a lacquered insert that acts as a grip.





05

Free 25 sliding door
Tray unit
Time bed

CLASSICAL, ELEGANT AND STYLISH

classicità, eleganza e stile







L'anta Free in versione scorrevole si differenzia per lo spessore maggiorato di 25 mm, in cui si può montare la semplice maniglia ad incasso Side, che garantisce contemporaneamente una presa sicura e la totale pulizia dell'anta.

The sliding version of the Free door differs in its greater thickness of 25 mm, which can be provided with the simple Side encased handle, that ensures safe grip and uncluttered lines for the door.





Gli elementi contenitori Tray si distinguono per la possibilità di avere il piano di appoggio in diversi materiali. Qui sono presentati in Laminam® finitura Noir Desir; sono disponibili anche le finiture Calacatta Lucido e Pietra di Savoia.

Tray storage elements are distinguished by the option of different materials for the top. Here we present Laminam® with a Noir Desir finish; also available with glossy Calacatta and Pietra di Savoia finishes.

06

Fascia sliding door
City bed

**SERENE,
MINIMALIST
AND
ELEGANT**

serenità, minimalismo ed eleganza







L'interno di ogni armadio si adatta ad ogni tipo di esigenza, grazie alla possibilità di essere attrezzato con cassettiere, ripiani e portabiancheria estraibili.

The inside of each wardrobe can be adapted to any needs with drawer sets, shelves and pull-out underwear trays.



07

Fascia Grafica sliding door

**UNIQUE,
REFINED
AND
DECORATIVE**

unicità, ricerca e decoro





08

Gola 25 sliding door
Tetris storage units

**MODERN,
WELL-
BALANCED
AND
EFFECT**

modernità, armonia e gioco







L'anta Gola con spessore 25 mm, conferisce all'armadio un carattere minimale e di classe. Completano l'arredo dello spazio spogliatoio, raffinati contenitori con basamento metallico ed un elemento a ponte, che può essere piano d'appoggio oppure una pratica seduta.

The 25 mm thick Gola door gives a classy, minimal look to the wardrobe. The closet area is completed with refined storage units on a metal base and an overhead element which can serve as a shelf or practical bench.



CABINE ARMADIO
WALK-IN CLOSETS

Eureka p. 154, 174

Side p. 160

Wall p. 142, 168

Sistema Scorrevole Slide Show
Slide Show sliding system
p. 62, 142, 160, 168

OI

Decor 1 sliding door
Tetris unit
Elegance bed
Wall walk-in closet
Slide Show sliding system

DESIGN, BALANCE AND STYLE

disegno, equilibrio e stile









L'essenzialità del profilo a tutta altezza in alluminio verniciato, unita alla raffinatezza dell'insero in vetro laccato Bianco, sono gli elementi che definiscono l'estetica dell'anta Decor 1.

The essential styling of the full height, painted aluminium profile, together with a refined insert in white lacquered glass finish, define the aesthetics of the Decor 1 door.



Un esclusivo gioco di linee e curve disegnano la sottile testiera e il piedino sagomato, componenti che fanno di Elegance un letto leggero e raffinato.

An exclusive perspective created by lines and curves designs the slim headboard and shaped leg, components that make Elegance a refined, airy bed.





Strutture con boiserie in finitura laccato o legno, compongono la cabina Wall in appoggio su panca e attrezzata con cassettiere, ripiani, tubi appendiabiti e accessori estraibili come il portapantaloni.

A corredo della cabina è disponibile il sistema di chiusura scorrevole Slide Show, con binario a soffitto o a parete, e ante in telaio Brunito e vetro temperato Trasparente, Fumè o Bronzato.

Structures with lacquered or wood boiserie panelling make up the Wall closet standing on a bench and fitted with drawer sets, shelves, clothes hanger rods and pull-out accessories like the trouser rack.

The closet is available with a Slide Show closing system, with ceiling or wall rack and door with a burnished frame and Transparent, Fumè or Bronzato toughened glass.



02

Specchio sliding door
Eureka walk-in closet

ORDER, ELEGANCE AND STYLE

ordine, eleganza e stile







Ripiani e attrezzature si inseriscono lungo i raffinati montanti metallici pavimento/parete che costituiscono il sistema Eureka, creando una soluzione d'arredo che si distingue per stile e qualità.

Shelves and internal fittings are inserted along the refined metal floor/wall uprights that make up the Eureka system to create decor distinguished by style and quality.



03

Side walk-in closet
Full Vip unit
Cube Legno padded insert bed
Slide Show sliding system

HARMONY, WEAVE AND COLOUR

armonia, trama e colore







Con i contenitori Full Vip, si possono usare finiture con toni cromatici in armonia, oppure giocare con piacevoli contrasti che ne enfatizzano il disegno.

Full Vip storage units can come in finishes with a harmonious colour scheme, or with pleasant contrasts which highlight their design.





La cabina armadio Side è qui sviluppata su tre lati con struttura in Olmo Cotto, attrezzata con ripiani e cassettiere laccati Lava, tubi appendiabiti e accessori in finitura Brunito. A chiusura dello spazio, il sistema scorrevole Slide Show con binario a soffitto.

The Side walk-in closet shown develops on three sides with an Olmo Cotto structure fitted with Lava lacquered shelves and drawer sets, clothes hanger rods and accessories with a Brunito finish. The area is closed by a Slide Show sliding system with ceiling rack.



01

Wall walk-in closet
Slide Show sliding system

FREEDOM, HARMONY AND ORDER

libertà, armonia e ordine







Tutte le cabine della collezione 5.0, sono corredate dalla nuova serie di accessori con tubi appendiabiti Deluxe, che si distinguono per il profilo con sezione rettangolare in finitura Brunito o Bianco, e l'applicazione di una speciale gomma anti-sdruciollo che evita lo scivolamento degli appendini.

All the closets in the 5.0 collection come with a new series of accessories and Deluxe clothes hanger rods distinguished by their rectangular profile with Brunito or Bianco finish, and a special non-slip rubber covering that prevents clothes hangers from sliding.



05

Eureka walk-in closet

**AIRY,
MINIMALIST
AND
GOOD LOOKS**

leggerezza, minimalismo ed estetica







DATI TECNICI
TECHNICAL DATA

Armadi ante battenti p. 182
Hinged doors wardrobes

Armadi ante scorrevoli p. 184
Sliding doors wardrobes

Accessori interni armadi p. 189
Internal wardrobe accessories

Maniglie armadi p. 194
Wardrobe handles

Contenitori e maniglie p. 197
Storage units and handles

Sistema letti p. 204
Bed sets

Finiture p. 208
Finishes

ARMADIO ANTA FREE WARDROBE FREE DOOR

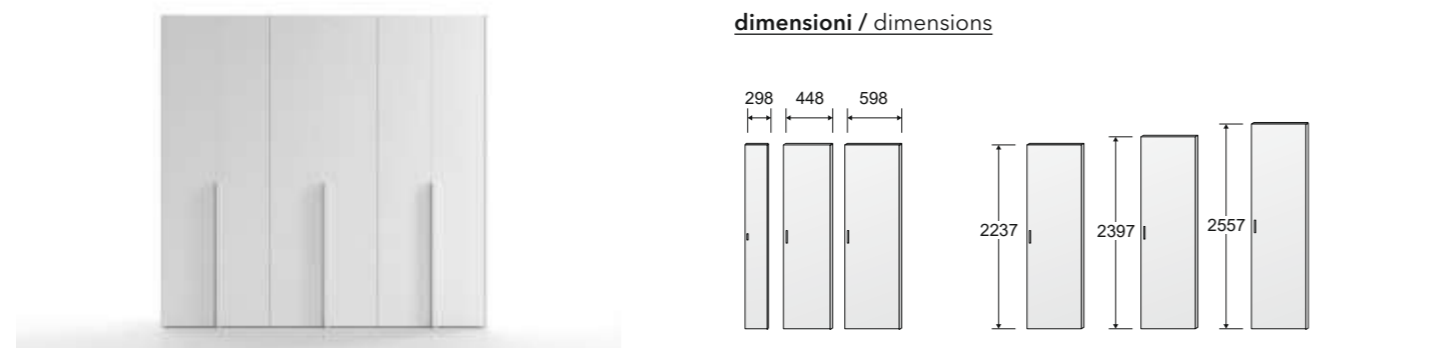

Anta disponibile nelle finiture melaminico, materico e in tutte le tonalità laccate opache e laccate opache a poro aperto. Maniglia Stilo di serie.
 Door available with a melamine or textured finish in all matt lacquered and open pore matt lacquered shades. Stilo standard handle.

ARMADIO ANTA LINEA WARDROBE LINEA DOOR

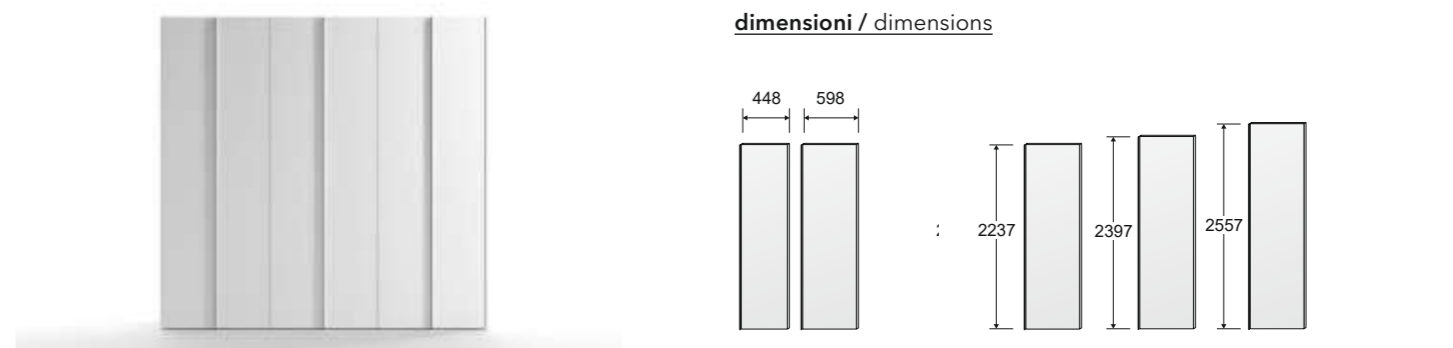

Anta disponibile nelle finiture melaminico, materico e in tutte le tonalità laccate opache e laccate opache a poro aperto.
 Maniglia in alluminio, laccata in tutti i colori. Se abbinata a finiture melaminiche venate o materiche, la tinta è prevista in tonalità con la stessa.
 Door available with a melamine or textured finish in all matt lacquered and open pore matt lacquered shades.
 Aluminium handle, lacquered in any colour. If matched with melamine grained or textured finishes, the colours are the same.

ARMADIO ANTA GO WARDROBE GO DOOR

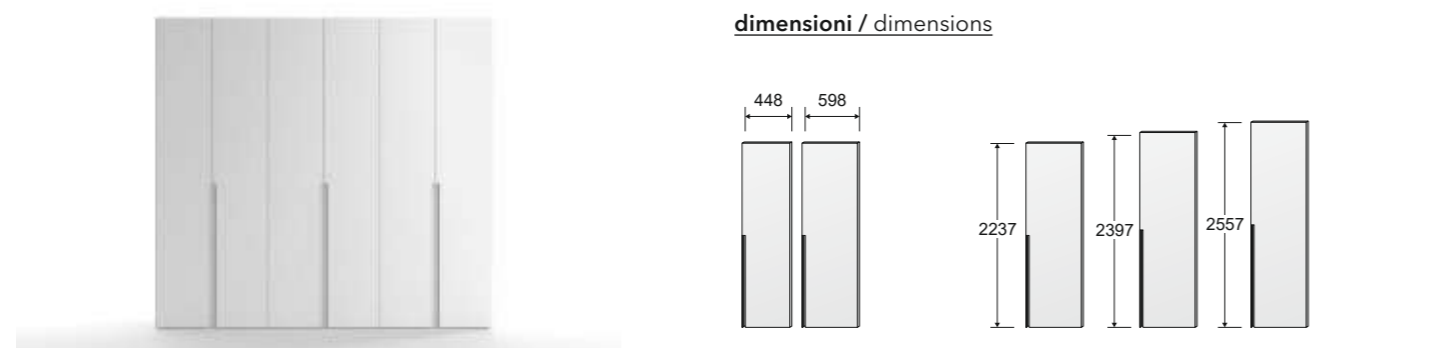

Anta disponibile nelle finiture melaminico, materico e in tutte le tonalità laccate opache e laccate opache a poro aperto. Maniglia in alluminio, laccata in tutti i colori. Se abbinata a finiture melaminiche venate o materiche, la tinta è prevista in tonalità con la stessa.
 Door available with a melamine or textured finish in all matt lacquered and open pore matt lacquered shades. Aluminium handle, lacquered in any colour. If matched with melamine grained or textured finishes, the colours are the same.

ARMADIO ANTA 30-60 WARDROBE 30-60 DOOR

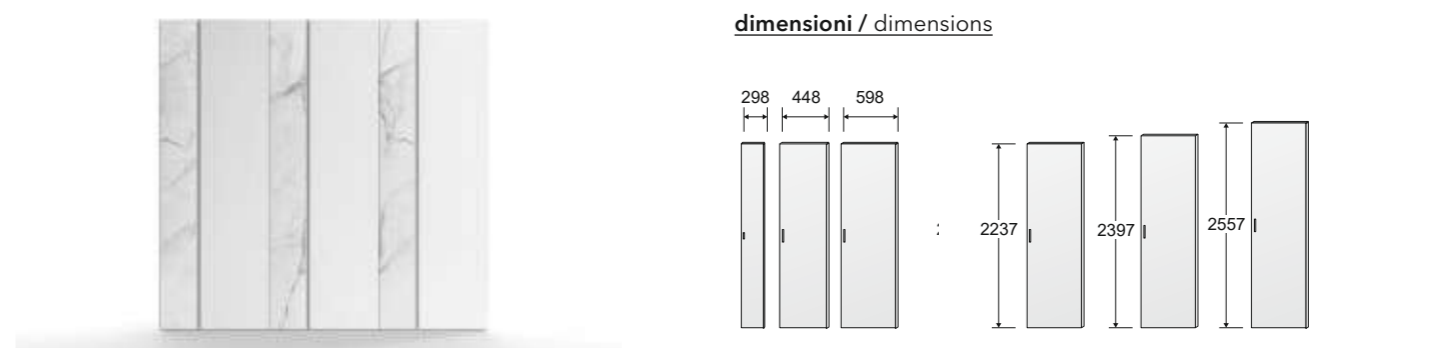

Anta disponibile nelle finiture melaminico, materico e in tutte le tonalità laccate opache e laccate opache a poro aperto. L'anta L 298 può essere anche grafica, con stampa digitale da scegliere fra i 6 decori presenti a catalogo, in Laminam®, oppure in vetro in tutte le tonalità laccate. Maniglia Stilo di serie oppure profilo in alluminio, laccato in tutti i colori. Se abbinato a finiture melaminiche venate o materiche, la tinta è prevista in tonalità con la stessa.
 Door available with a melamine or textured finish in all matt lacquered and open pore matt lacquered shades. The L 298 door can be provided with a digital printed pattern from a choice of six in the catalogue, or in Laminam®. Stilo standard handle or aluminium profile, lacquered in any colour. If matched with melamine grained or textured finishes, the colours are the same.

ARMADIO ANTA GOLA WARDROBE GOLA DOOR

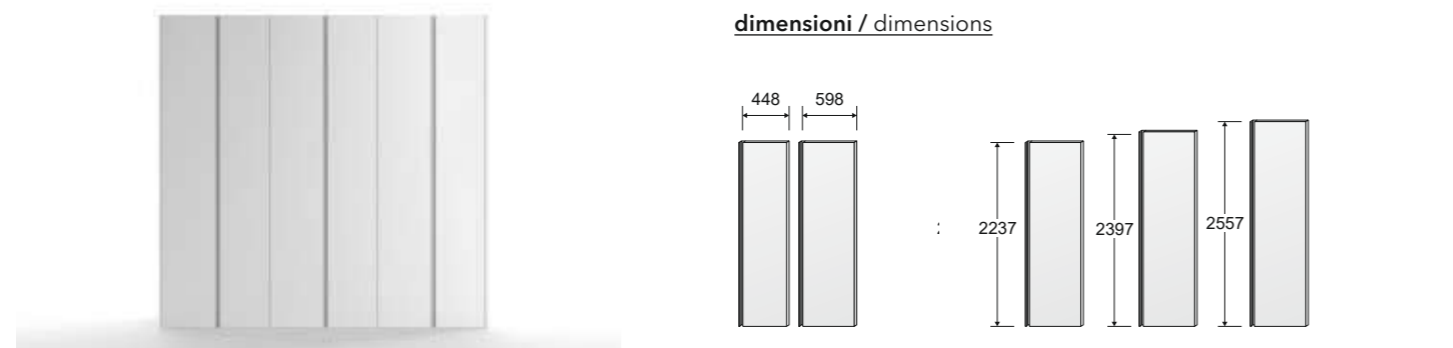

Anta disponibile nelle finiture melaminico, materico e in tutte le tonalità laccate opache e laccate opache a poro aperto. Maniglia in alluminio, laccata in tutti i colori. Se abbinata a finiture melaminiche venate o materiche, la tinta è prevista in tonalità con la stessa.
 Door available with a melamine or textured finish in all matt lacquered and open pore matt lacquered shades. Aluminium handle, lacquered in any colour. If matched with melamine grained or textured finishes, the colours are the same.

ARMADIO ANTA SPECCHIO WARDROBE SPECCHIO DOOR

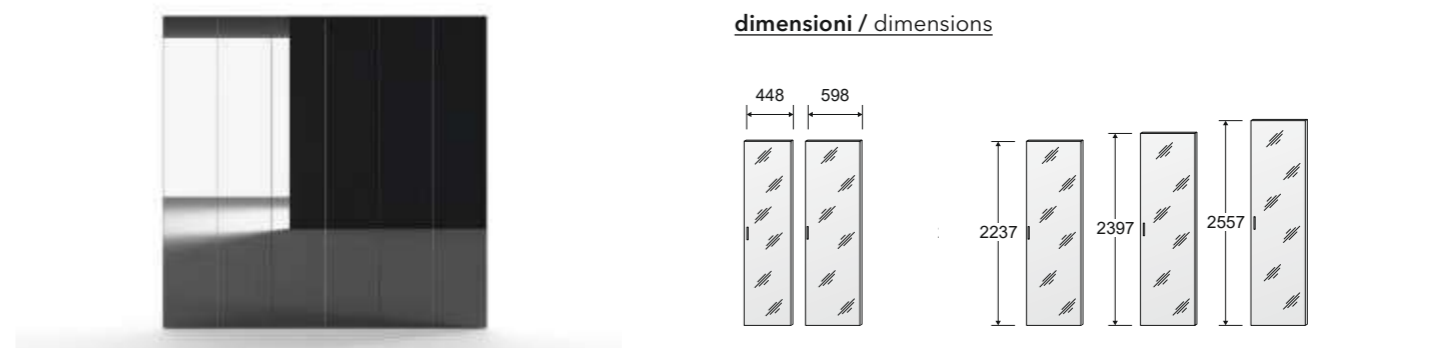

Anta specchio disponibile nelle finiture Chiaro e Fumè; pannello interno disponibile nelle finiture melaminico, materico e in tutte le tonalità laccate opache e laccate opache a poro aperto. Maniglia Stilo di serie.
 Specchio door available in the Chiaro or Fumè finishes; internal melamine or textured panel available in all matt lacquered and open pore matt lacquered shades. Stilo standard handle.

ARMADIO ANTA CROSS WARDROBE CROSS DOOR

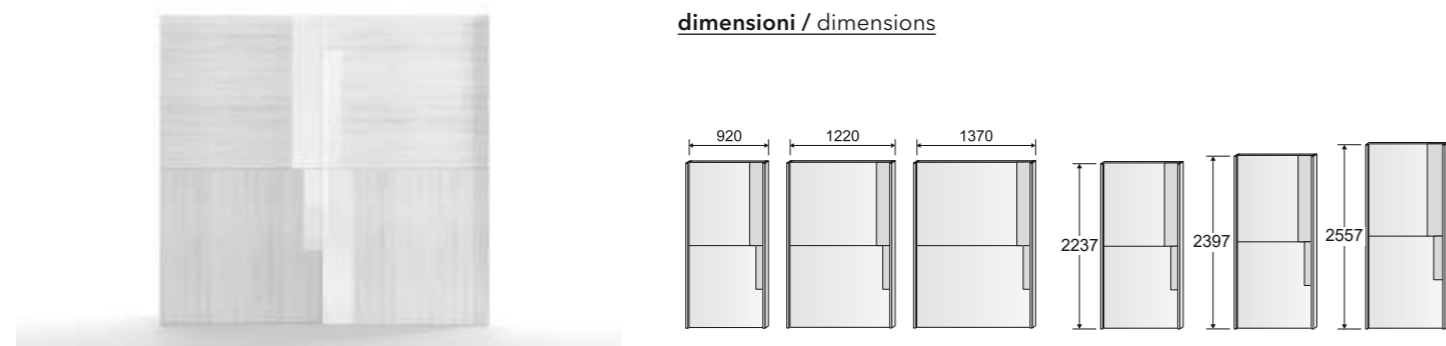

Anta disponibile nelle finiture melaminico, materico e in tutte le tonalità laccate opache e laccate opache a poro aperto; applicazioni in specchio oppure vetro in tutte le tonalità laccate. Maniglia in alluminio, laccata in tutti i colori. Se abbinata a finiture melaminiche venate o materiche, la tinta è prevista in tonalità con la stessa.
 Door available with a melamine or textured finish, in all matt lacquered and open pore matt lacquered shades; mirror or glass applications in any of the lacquered shades. Aluminium handle, lacquered in any colour. If matched with melamine grained or textured finishes, the colours are the same.

ARMADIO ANTA DAMA WARDROBE DAMA DOOR

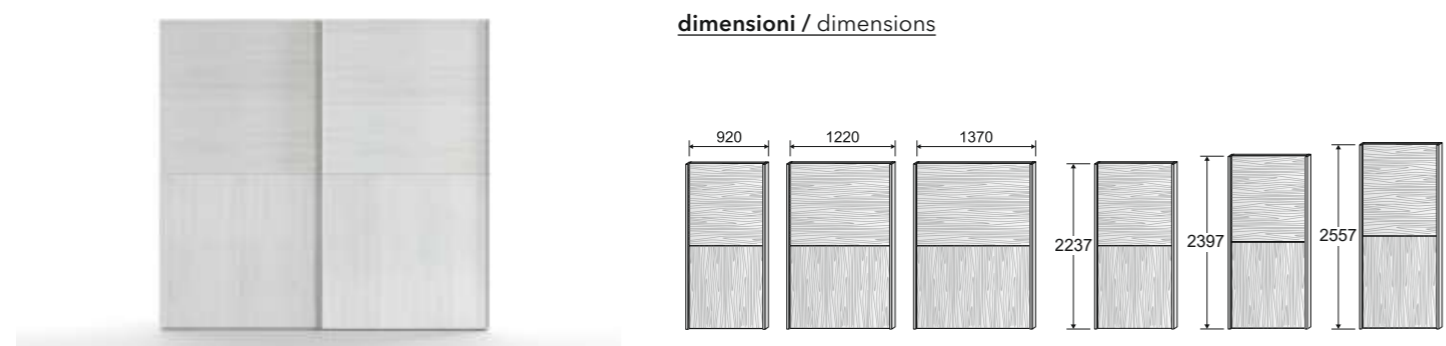

Anta disponibile nelle finiture melaminico, materico e in tutte le tonalità laccate opache e laccate opache a poro aperto. Maniglia in alluminio, laccata in tutti i colori. Se abbinata a finiture melaminiche venate o materiche, la tinta è prevista in tonalità con la stessa.
 Door available with a melamine or textured finish, in all matt lacquered and open pore matt lacquered shades. Aluminium handle, lacquered in any colour. If matched with melamine grained or textured finishes, the colours are the same.

ARMADIO ANTA DECOR 1 WARDROBE DECOR 1 DOOR

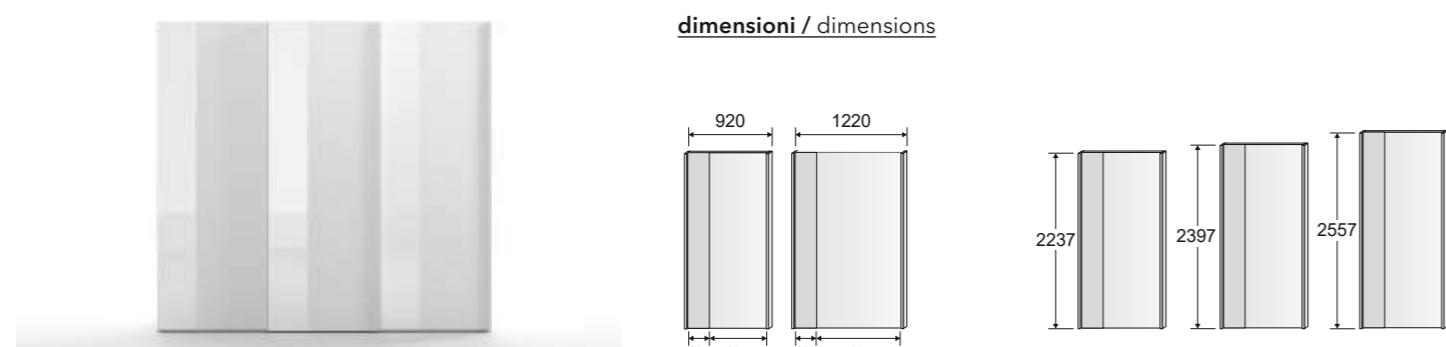

Anta disponibile nelle finiture melaminico, materico e in tutte le tonalità laccate opache e laccate opache a poro aperto; inserto disponibile in vetro, in tutte le tonalità laccate, oppure in Laminam®. Maniglia in alluminio, laccata in tutti i colori. Se abbinata a finiture melaminiche venate o materiche, la tinta è prevista in tonalità con la stessa.
 Door available with a melamine or textured finish, in all matt lacquered and open pore matt lacquered shades; glass insert available in any of the lacquered colours, or in Laminam®. Aluminium handle, lacquered in any colour. If matched with melamine grained or textured finishes, the colours are the same.

ARMADIO ANTA DECOR 2 WARDROBE DECOR 2 DOOR

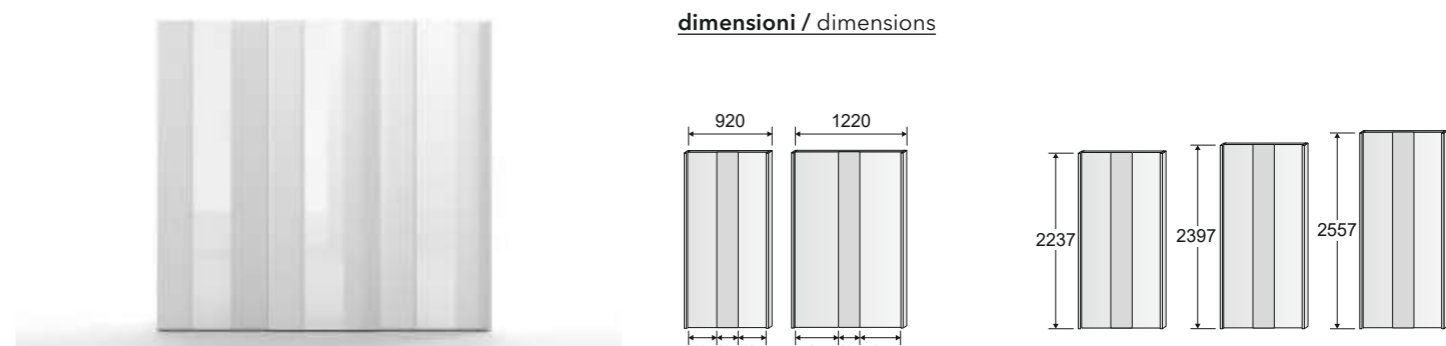

Anta disponibile nelle finiture melaminico, materico e in tutte le tonalità laccate opache e laccate opache a poro aperto; inserto disponibile in vetro, in tutte le tonalità laccate, oppure in Laminam®. Maniglia in alluminio, laccata in tutti i colori. Se abbinata a finiture melaminiche venate o materiche, la tinta è prevista in tonalità con la stessa.
 Door available with a melamine or textured finish, in all matt lacquered and open pore matt lacquered shades; glass insert available in any of the lacquered colours, or in Laminam®. Aluminium handle, lacquered in any colour. If matched with melamine grained or textured finishes, the colours are the same.

ARMADIO ANTA FASCIA WARDROBE FASCIA DOOR

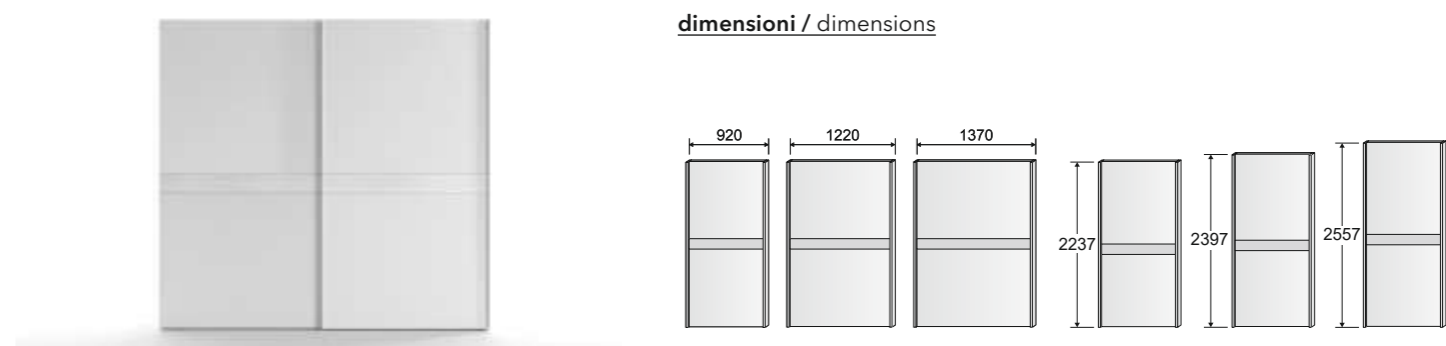

Anta disponibile nelle finiture melaminico, materico e in tutte le tonalità laccate opache e laccate opache a poro aperto. Maniglia in alluminio, laccata in tutti i colori. Se abbinata a finiture melaminiche venate o materiche, la tinta è prevista in tonalità con la stessa.
 Door available with a melamine or textured finish, in all matt lacquered and open pore matt lacquered shades. Aluminium handle, lacquered in any colour. If matched with melamine grained or textured finishes, the colours are the same.

ARMADIO ANTA FASCIA GRAFICA WARDROBE FASCIA GRAFICA DOOR

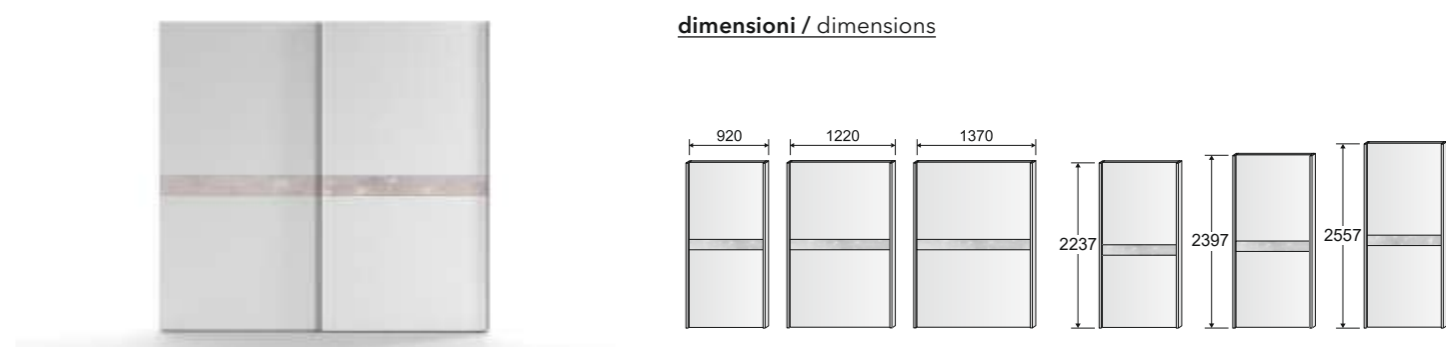

Anta disponibile nelle finiture melaminico, materico e in tutte le tonalità laccate opache e laccate opache a poro aperto; fascia grafica con stampa digitale da scegliere fra i 6 decori presenti a catalogo. Maniglia disponibile in alluminio, laccata in tutti i colori. Se abbinata a finiture melaminiche venate o materiche, la tinta è prevista in tonalità con la stessa.
 Door available with a melamine or textured finish, in all matt lacquered and open pore matt lacquered shades; band with digital printed pattern from a choice of six in the catalogue. Aluminium handle available, lacquered in any colour. If matched with melamine grained or textured finishes, the colours are the same.

ARMADIO ANTA FREE 25 WARDROBE FREE 25 DOOR

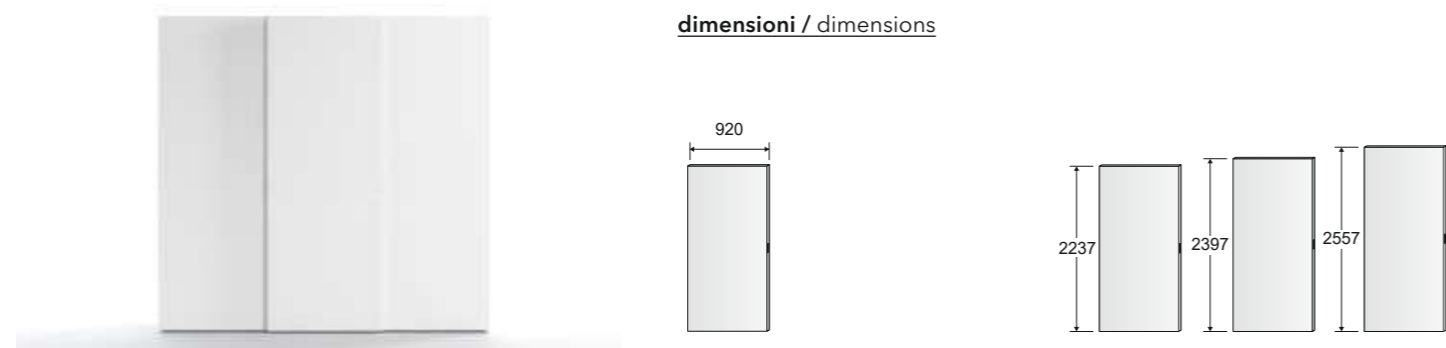

Anta disponibile nelle finiture melaminico, materico e in tutte le tonalità laccate opache e laccate opache a poro aperto. Maniglia Side di serie.
Door available with a melamine or textured finish, in all matt lacquered and open pore matt lacquered shades. Side standard handle.

ARMADIO ANTA SIMPLY SIMPLY DOOR

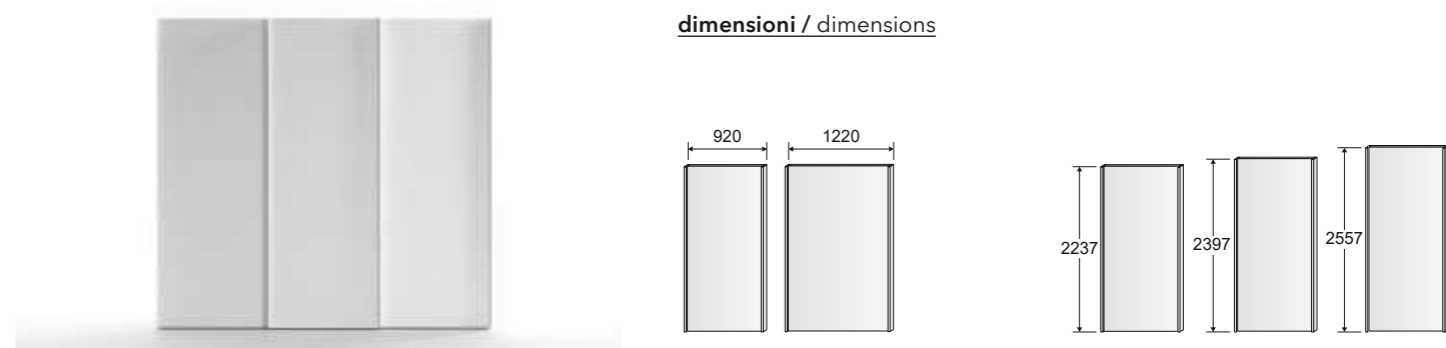

Anta disponibile nelle finiture melaminico, materico e in tutte le tonalità laccate opache e laccate opache a poro aperto. Maniglia in alluminio, laccata in tutti i colori. Se abbinata a finiture melaminiche venate o materiche, la tinta è prevista in tonalità con la stessa.
Door available with a melamine or textured finish, in all matt lacquered and open pore matt lacquered shades. Aluminium handle lacquered in any colour. If matched with melamine grained or textured finishes, the colours are the same.

ARMADIO ANTA GO 25 WARDROBE GO 25 DOOR

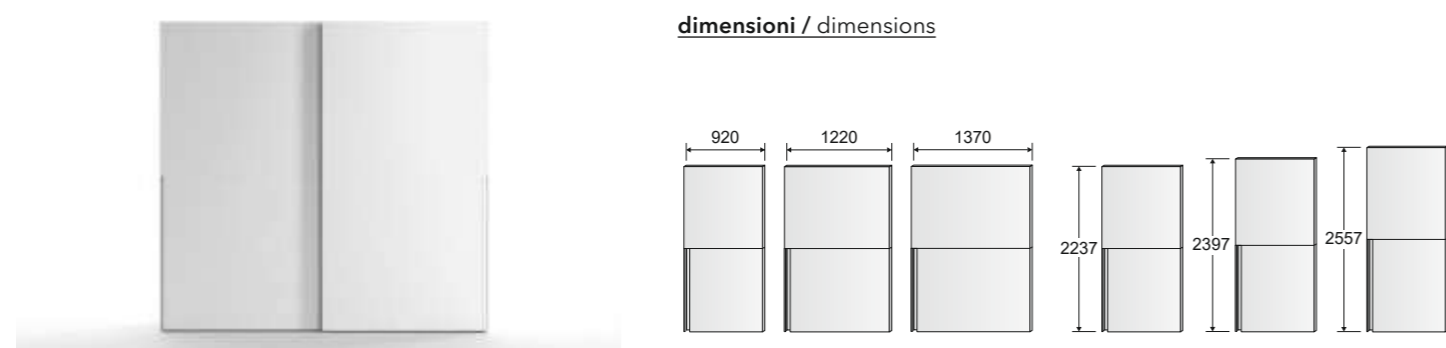

Anta disponibile nelle finiture melaminico, materico e in tutte le tonalità laccate opache e laccate opache a poro aperto. Maniglia in alluminio, laccata in tutti i colori. Se abbinata a finiture melaminiche venate o materiche, la tinta è prevista in tonalità con la stessa.
Door available with a melamine or textured finish, in all matt lacquered and open pore matt lacquered shades. Aluminium handle lacquered in any colour. If matched with melamine grained or textured finishes, the colours are the same.

ARMADIO ANTA SPECCHIO SPECCHIO DOOR

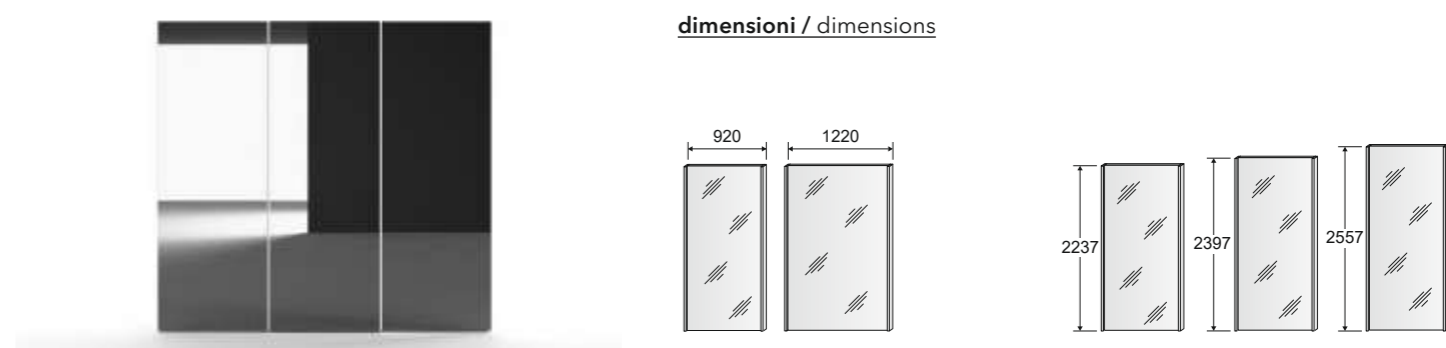

Anta specchio disponibile nelle finiture Chiaro e Fumè; pannello interno disponibile nelle finiture melaminico. Maniglia in alluminio, laccata in tutti i colori. Se abbinata a finiture melaminiche venate o materiche, la tinta è prevista in tonalità con la stessa.
Mirror door available with a Chiaro or Fumè finish; melamine finish internal panel available. Aluminium handle lacquered in any colour. If matched with melamine grained or textured finishes, the colours are the same.

ARMADIO ANTA GOLA 25 WARDROBE GOLA 25 DOOR

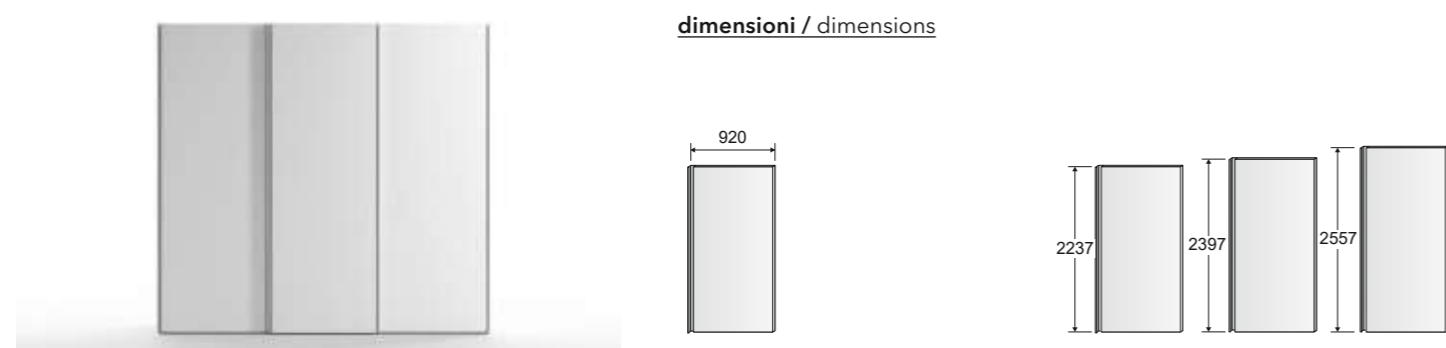

Anta disponibile nelle finiture melaminico, materico e in tutte le tonalità laccate opache e laccate opache a poro aperto. Maniglia in alluminio, laccata in tutti i colori. Se abbinata a finiture melaminiche venate o materiche, la tinta è prevista in tonalità con la stessa.
Door available with a melamine or textured finish, in all matt lacquered and open pore matt lacquered shades. Aluminium handle lacquered in any colour. If matched with melamine grained or textured finishes, the colours are the same.

ARMADIO ANTA TERRY TERRY DOOR

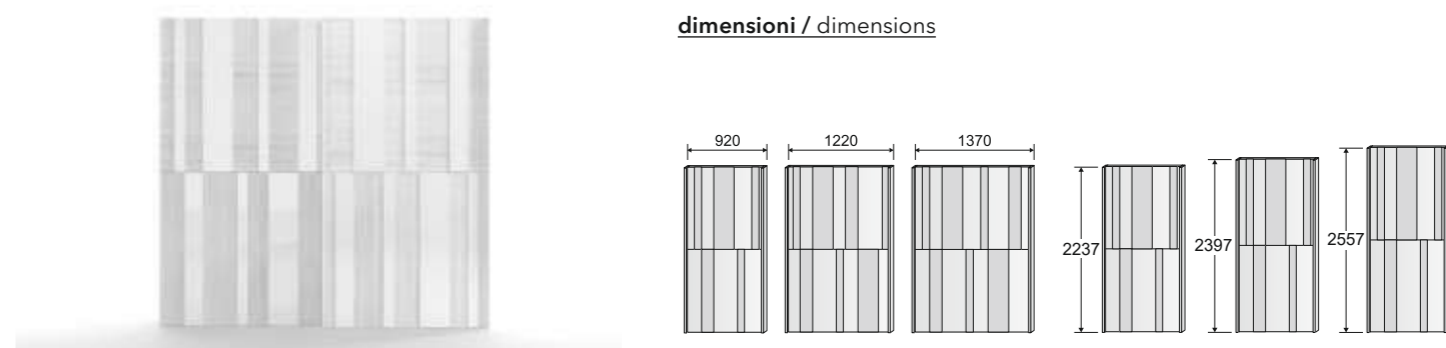

Anta disponibile nelle finiture melaminico, materico e in tutte le tonalità laccate opache e laccate opache a poro aperto; applicazioni in specchio oppure vetro in tutte le tonalità laccate. Maniglia in alluminio, laccata in tutti i colori. Se abbinata a finiture melaminiche venate o materiche, la tinta è prevista in tonalità con la stessa.
Door available with a melamine or textured finish, in all matt lacquered and open pore matt lacquered shades; mirror or glass applications in any of the lacquered shades. Aluminium handle lacquered in any colour. If matched with melamine grained or textured finishes, the colours are the same.

ARMADIO ANTA TETRIS WARDROBE TETRIS DOOR

dimensioni / dimensions

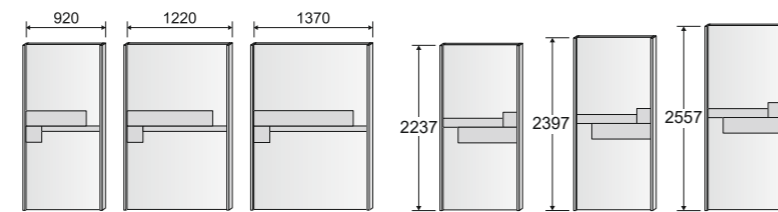

Anta disponibile nelle finiture melaminico, materico e in tutte le tonalità laccate opache e laccate opache a poro aperto; applicazioni in specchio oppure vetro in tutte le tonalità laccate. Maniglia in alluminio, laccata in tutti i colori. Se abbinata a finiture melaminiche venate o materiche, la tinta è prevista in tonalità con la stessa.

Door available with a melamine or textured finish, in all matt lacquered and open pore matt lacquered shades; mirror or glass applications in any of the lacquered shades. Aluminium handle lacquered in any colour. If matched with melamine grained or textured finishes, the colours are the same.

APPENDIABITI CLOTHES HANGERS

tubo appendiabiti / clothes hanger rod



Tubo appendiabiti standard Brunito Metal Grey.
Brunito Metal Grey standard clothes hanger rod.

tubo appendiabiti Deluxe* / Deluxe clothes hanger rod*



Tubo appendiabiti Deluxe Bianco o Brunito, con gommino antisfregamento.
Bianco or Brunito Deluxe clothes hanger rod with non-slip rubber.

servetto appendiabiti / garment lift



Servetto appendiabiti Brunito con rotazione verso il basso.
Brunito garment lift with downward rotation.

* Di serie per cabine armadio; optional per armadi battenti e scorrevoli (solo Brunito).

* Standard on walk-in closets; optional for wardrobes with hinged or sliding doors (Brunito only).

ATTREZZATURA INTERNA INTERNAL FITTINGS

portapantaloni / trouser rack



Brunito pull-out trouser rack.
Standard hanging rail white covered.

vaschetta estraibile/ pull-out tray



Brunito pull-out tray.
Standard hanging rail white covered.

ripiano portascarpe / shoe shelf



Ripiano portascarpe con profili in alluminio Brunito.
Shoe shelf with Brunito aluminium profiles.

ILLUMINAZIONE ILLUMINATION

luce led su coperchio / LED light on top cover



Luce led su coperchio a sensore di movimento.
LED light with motion sensor, on top cover.

portabiancheria estraibile / pull-out underwear tray



Sacche trapuntate portabiancheria con estraibili Brunito e tessuto marrone.
Padded underwear bags with Brunito pull-out and brown fabric.

cassettiera interna / internal drawer set



Cassettiera interna ad estrazione parziale, con guide Quadro rallentate in chiusura.
Partial pull-out drawer set with Quadro soft-closing runners.

luce led su fianco / LED light on side panel



Luce led su fianco a sensore di movimento.
LED light with motion sensor on side panel.

RIPARTIZIONE INTERNA ARMADI WARDROBE INTERNAL PARTITIONS



finitura struttura interna / internal fittings finish

Texture



Un'attrezzatura completa, liberamente posizionabile, che garantisce una precisa organizzazione degli spazi. Design essenziale e originalità del dettaglio sono il risultato di un'attenta ricerca formale.
 A complete set of fittings to position anywhere guarantees orderly organisation of space. Essential design and original details are the result of careful research.

ANTE BATTENTI HINGED DOORS

D2

Disponibile nella finitura Cromo Satinato.
Available in Cromo Satinato.

MOOD

Disponibile in tutti i colori laccati. Se abbinata a finiture melaminiche venate o materiche, la tinta è prevista in tonalità con la stessa.
Available in any of the lacquered colours. If matched with melamine grained or textured finishes, the colours are the same.

STILO (di serie) / STILO (standard)

Disponibile nelle finiture Bianco Alaska, Perla, Grigio Seta, Olmo Bianco (in tinta), Lava e in tutti i colori laccati. Se abbinata a finiture melaminiche venate o materiche, la tinta è prevista in tonalità con la stessa.
Available with the Bianco Alaska, Perla, Grigio Seta, Olmo Bianco (the same) Lava finishes and in any of the lacquered colours. If matched with melamine grained or textured finishes, the colours are the same.

W

Disponibile nelle finiture Bianco Alaska, Perla, Grigio Seta, Lava e in tutti i colori laccati. Se abbinata a finiture melaminiche venate o materiche, la tinta è prevista in tonalità con la stessa.
Available with the Bianco Alaska, Perla, Grigio Seta, Lava finishes and in any of the lacquered colours. If matched with melamine grained or textured finishes, the colours are the same.

GIRO (serratura ad asta) / GIRO (lock rod)

Disponibile nella finitura Cromo.
Available in Cromo.

Q2

Disponibile nelle finiture Bianco Alaska, Perla, Grigio Seta, Lava e in tutti i colori laccati. Se abbinata a finiture melaminiche venate o materiche, la tinta è prevista in tonalità con la stessa.
Available with the Bianco Alaska, Perla, Grigio Seta, Lava finishes and in any of the lacquered colours. If matched with melamine grained or textured finishes, the colours are the same.

TREND T1

Disponibile nelle finiture Bianco Alaska, Perla, Grigio Seta, Lava e in tutti i colori laccati. Se abbinata a finiture melaminiche venate o materiche, la tinta è prevista in tonalità con la stessa.
Available with the Bianco Alaska, Perla, Grigio Seta, Lava finishes and in any of the lacquered colours. If matched with melamine grained or textured finishes, the colours are the same.

X1

Disponibile nelle finiture Bianco Alaska, Perla, Grigio Seta, Lava e in tutti i colori laccati. Se abbinata a finiture melaminiche venate o materiche, la tinta è prevista in tonalità con la stessa.
Available with the Bianco Alaska, Perla, Grigio Seta, Lava finishes and in any of the lacquered colours. If matched with melamine grained or textured finishes, the colours are the same.

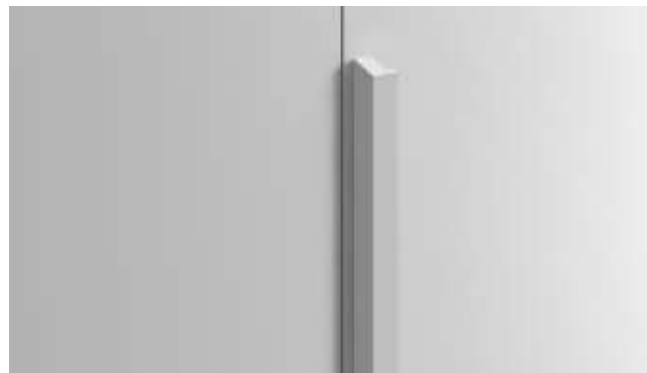
H2

Disponibile nelle finiture Bianco Alaska, Perla, Grigio Seta, Lava e in tutti i colori laccati. Se abbinata a finiture melaminiche venate o materiche, la tinta è prevista venata ed in tonalità con la stessa.
Available with the Bianco Alaska, Perla, Grigio Seta, Lava finishes and in any of the lacquered colours. If matched with melamine grained or textured finishes, the colours are the same.

RING

Disponibile nella finitura Brunito.
Available in Brunito.

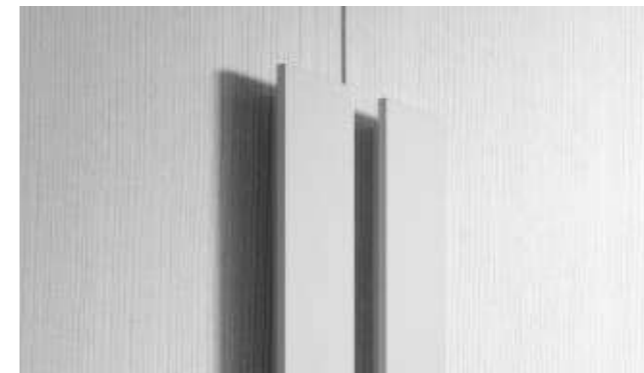
TREND T2

Disponibile nelle finiture Bianco Alaska, Perla, Grigio Seta, Lava e in tutti i colori laccati. Se abbinata a finiture melaminiche venate o materiche, la tinta è prevista in tonalità con la stessa.
Available with the Bianco Alaska, Perla, Grigio Seta, Lava finishes and in any of the lacquered colours. If matched with melamine grained or textured finishes, the colours are the same.

ANTA SCORREVOLE LISCIA 25 SLIDING DOOR LISCIA 25

SIDE



Disponibile nella finitura Brunito.
Available in Brunito.

STILO (di serie) / STILO (standard)



Disponibile nelle finiture Bianco Alaska, Perla, Grigio Seta, Olmo Bianco (in tinta), Lava e in tutti i colori laccati. Se abbinata a finiture melaminiche venate o materiche, la tinta è prevista in tonalità con la stessa.
Available with the Bianco Alaska, Perla, Grigio Seta, Olmo Bianco (the same) Lava finishes and in any of the lacquered colours. If matched with melamine grained or textured finishes, the colours are the same.

H2



Disponibile nelle finiture Bianco Alaska, Perla, Grigio Seta, Lava e in tutti i colori laccati. Se abbinata a finiture melaminiche venate o materiche, la tinta è prevista in tonalità con la stessa.
Available with the Bianco Alaska, Perla, Grigio Seta, Lava finishes and in any of the lacquered colours. If matched with melamine grained or textured finishes, the colours are the same.

CABINE ARMADIO WALK-IN CLOSETS

GOLA



Disponibile in tutti i colori laccati. Se abbinata a finiture melaminiche venate o materiche, la tinta è prevista in tonalità con la stessa.
Available in any of the lacquered colours. If matched with melamine grained or textured finishes, the colours are the same.

POWER



Disponibile nella finitura Brunito.
Available in Brunito.

W



Disponibile nelle finiture Bianco Alaska, Perla, Grigio Seta, Lava e in tutti i colori laccati. Se abbinata a finiture melaminiche venate o materiche, la tinta è prevista in tonalità con la stessa.
Available with the Bianco Alaska, Perla, Grigio Seta, Lava finishes and in any of the lacquered colours. If matched with melamine grained or textured finishes, the colours are the same.

TOP DREAM

dimensioni / dimensions

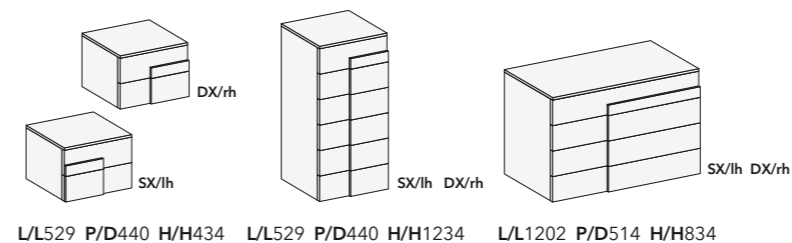

Collezione notte disponibile nelle finiture melaminico, materico e in tutte le tonalità laccate opache e laccate opache a poro aperto, sia per la scocca che per i frontali cassetto. Maniglie Dream 1 e Dream 2.
Bedroom collection available with a melamine or textured finish and in any of the matt lacquered and open pore matt lacquered finishes, for the carcass and drawer fronts. Dream 1 and Dream 2 handles.

FULL DREAM

dimensioni / dimensions

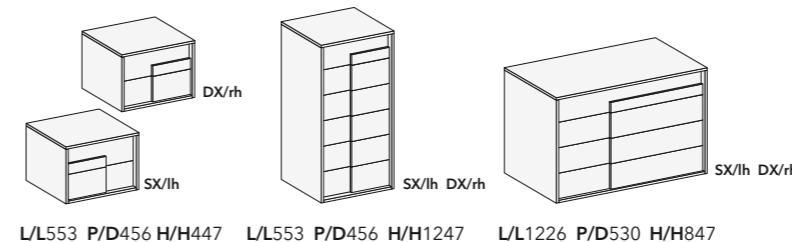

Collezione notte disponibile nelle finiture melaminico, materico e in tutte le tonalità laccate opache e laccate opache a poro aperto, sia per la scocca che per i frontali cassetto. Maniglie Dream 1 e Dream 2.
Bedroom collection available with a melamine or textured finish and in any of the matt lacquered and open pore matt lacquered finishes, for the carcass and drawer fronts. Dream 1 and Dream 2 handles.

TOP EASY

dimensioni / dimensions



Collezione notte disponibile nelle finiture melaminico, materico e in tutte le tonalità laccate opache e laccate opache a poro aperto, sia per la scocca che per i frontali cassetto. Maniglia Stilo di serie.
Bedroom collection available with a melamine or textured finish and in any of the matt lacquered and open pore matt lacquered finishes, for the carcass and drawer fronts. Stilo standard handle.

FULL EASY

dimensioni / dimensions



L/L553 P/D456 H/H447 L/L553 P/D456 H/H1247 L/L1226 P/D530 H/H847

Collezione notte disponibile nelle finiture melaminico, materico e in tutte le tonalità laccate opache e laccate opache a poro aperto, sia per la scocca che per i frontali cassetto. Maniglia Stilo di serie.
 Bedroom collection available with a melamine or textured finish and in any of the matt lacquered and open pore matt lacquered finishes, for the carcass and drawer fronts. Stilo standard handle.

TOP TREND

dimensioni / dimensions

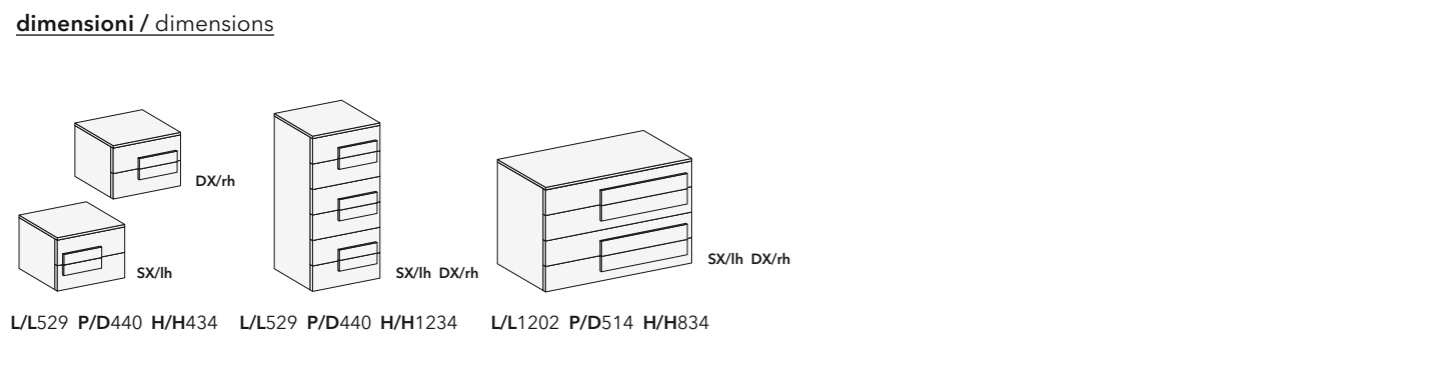

L/L529 P/D440 H/H434 L/L529 P/D440 H/H1234 L/L1202 P/D514 H/H834

Collezione notte disponibile nelle finiture melaminico, materico e in tutte le tonalità laccate opache e laccate opache a poro aperto, sia per la scocca che per i frontali cassetto. Maniglia T1 per comodino e settimanale, maniglia T2 per comò.
 Bedroom collection available with a melamine or textured finish and in any of the matt lacquered and open pore matt lacquered finishes, for the carcass and drawer fronts. T1 handle for bedside table and tallboy, T2 handle for dressing table.

FULL TREND

dimensioni / dimensions

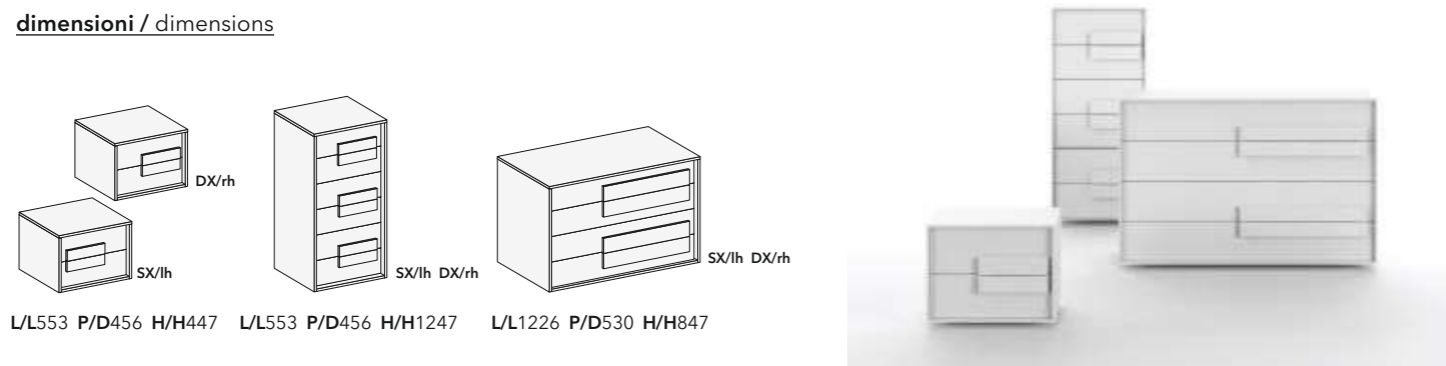

L/L553 P/D456 H/H447 L/L553 P/D456 H/H1247 L/L1226 P/D530 H/H847

Collezione notte disponibile nelle finiture melaminico, materico e in tutte le tonalità laccate opache e laccate opache a poro aperto, sia per la scocca che per i frontali cassetto. Maniglia T1 per comodino e settimanale, maniglia T2 per comò.
 Bedroom collection available with a melamine or textured finish and in any of the matt lacquered and open pore matt lacquered finishes, for the carcass and drawer fronts. T1 handle for bedside table and tallboy, T2 handle for dressing table.

TOP TWEET

dimensioni / dimensions

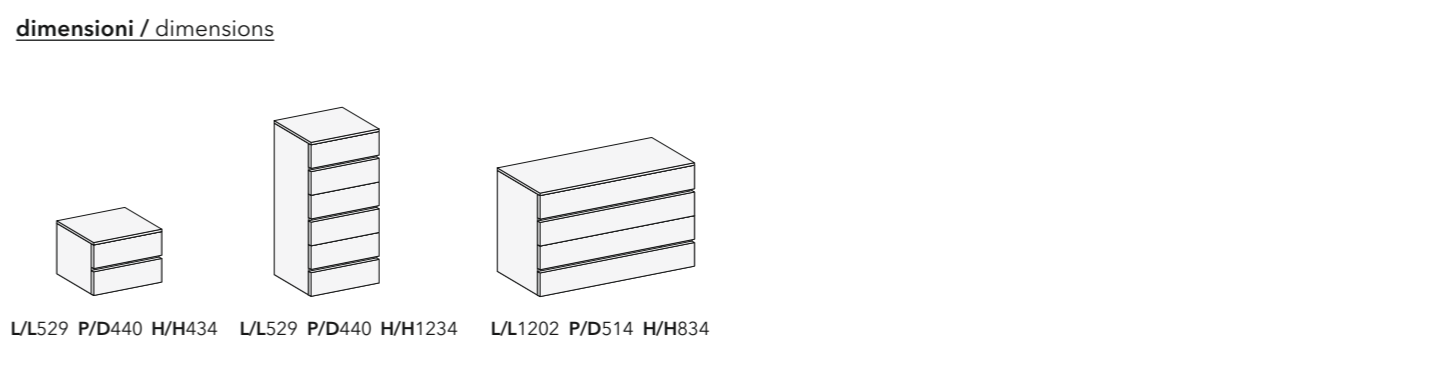

L/L529 P/D440 H/H434 L/L529 P/D440 H/H1234 L/L1202 P/D514 H/H834

Collezione notte disponibile nelle finiture melaminico, materico e in tutte le tonalità laccate opache e laccate opache a poro aperto, sia per la scocca che per i frontali cassetto. Maniglia Gola disponibile in alluminio, laccata in tutti i colori. Se abbinata a finiture melaminiche venate o materiche, la tinta è prevista in tonalità con la stessa.
 Bedroom collection available with a melamine or textured finish and in any of the matt lacquered and open pore matt lacquered finishes, for the carcass and drawer fronts. Gola handle available in aluminium lacquered in any colour. If matched with melamine grained or textured finishes, the colours are the same.

FULL TWEET

dimensioni / dimensions

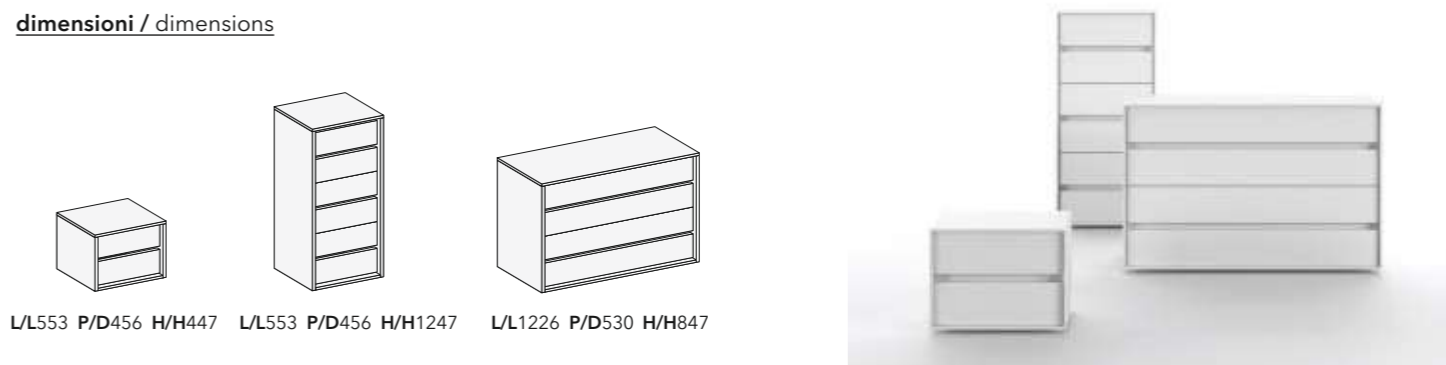

L/L553 P/D456 H/H447 L/L553 P/D456 H/H1247 L/L1226 P/D530 H/H847

Collezione notte disponibile nelle finiture melaminico, materico e in tutte le tonalità laccate opache e laccate opache a poro aperto, sia per la scocca che per i frontali cassetto. Maniglia Gola disponibile in alluminio, laccata in tutti i colori. Se abbinata a finiture melaminiche venate o materiche, la tinta è prevista in tonalità con la stessa.
 Bedroom collection available with a melamine or textured finish and in any of the matt lacquered and open pore matt lacquered finishes, for the carcass and drawer fronts. Gola handle available in aluminium lacquered in any colour. If matched with melamine grained or textured finishes, the colours are the same.

TOP VIP

dimensioni / dimensions

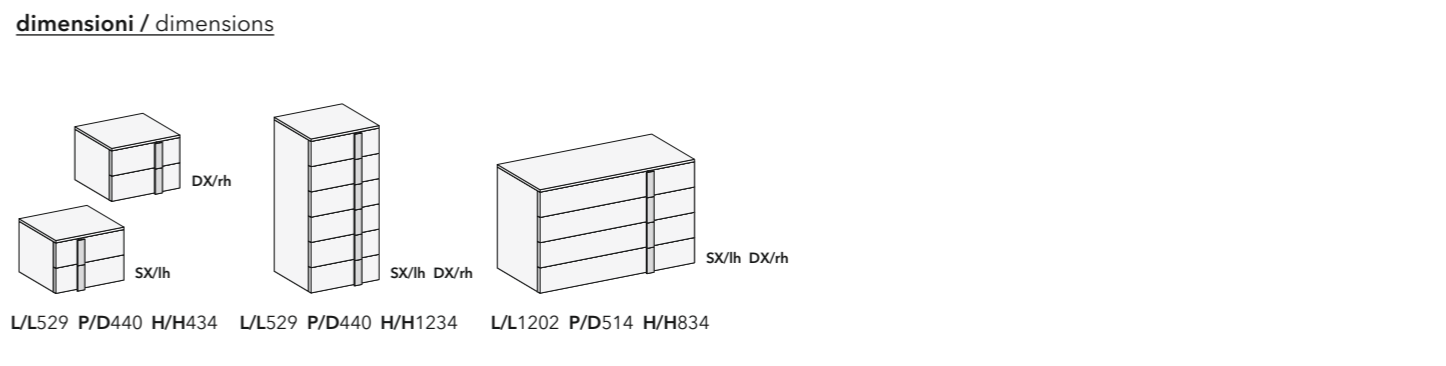

L/L529 P/D440 H/H434 L/L529 P/D440 H/H1234 L/L1202 P/D514 H/H834

Collezione notte disponibile nelle finiture melaminico, materico e in tutte le tonalità laccate opache e laccate opache a poro aperto, sia per la scocca che per i frontali cassetto. Maniglia X3.
 Bedroom collection available with a melamine or textured finish and in any of the matt lacquered and open pore matt lacquered finishes for the carcass and drawer fronts. X3 handle.

FULL VIP

dimensioni / dimensions

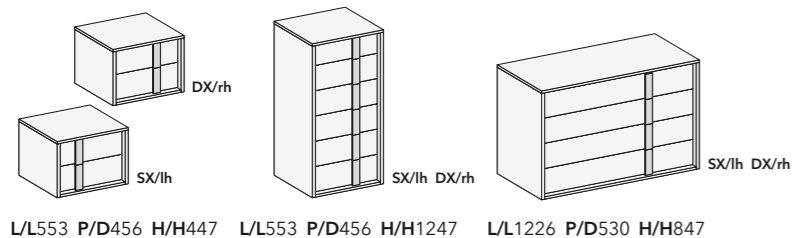

L/L553 P/D456 H/H447 L/L553 P/D456 H/H1247 L/L1226 P/D530 H/H847



Collezione notte disponibile nelle finiture melaminico, materico e in tutte le tonalità laccate opache e laccate opache a poro aperto, sia per la scocca che per i frontali cassetto. Maniglia X3.
Bedroom collection available with a melamine or textured finish and in any of the matt lacquered and open pore matt lacquered finishes for the carcass and drawer fronts. X3 handle.

COMODINO RAST

dimensioni / dimensions

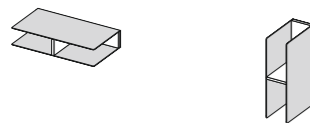

L/L600 P/D320 H/H160 L/L160 P/D320 H/H600



Il comodino Rast è composto da una scocca in metallo Antracite, con una schiena e dei divisori o ripiani in pannello, disponibili nelle finiture melaminico, materico e laccato opaco. È possibile posizionarlo sia in orizzontale che verticale.
The Rast bedside table has an Antracite metal carcass and a back panel, panel partitions or shelves available with a melamine, textured or matt lacquered finish. Can be placed either horizontally or vertically.

TRAY

dimensioni / dimensions



L/L552 P/D453 H/H429 L/L552 P/D453 H/H1249 L/L1227 P/D527 H/H845



Collezione notte disponibile nelle finiture melaminico, materico e in tutte le tonalità laccate opache e laccate opache a poro aperto, per scocca, frontali cassetto e top; il top è disponibile anche in vetro laccato o Laminam®.
Bedroom collection available with a melamine or textured finish and in any of the matt lacquered and open pore matt lacquered finishes for the carcass, drawer fronts and top; the top is also available in lacquered glass or Laminam®.

MANIGLIE

STILO contenitori Easy (di serie) / Easy storage units (standard)



Disponibile nelle finiture Bianco Alaska, Perla, Grigio Seta, Olmo Bianco (in tinta), Lava e in tutti i colori laccati. Se abbinata a finiture melaminiche venate o materiche, la tinta è prevista in tonalità con la stessa.
Available with the Bianco Alaska, Perla, Grigio Seta, Olmo Bianco (the same) Lava finishes and in any of the lacquered colours. If matched with melamine grained or textured finishes, the colours are the same.

RING contenitori Easy / Easy storage units



Disponibile nella finitura Brunito.
Available in Brunito.

W contenitori Easy / Easy storage units



Disponibile nelle finiture Bianco Alaska, Perla, Grigio Seta, Lava e in tutti i colori laccati. Se abbinata a finiture melaminiche venate o materiche, la tinta è prevista in tonalità con la stessa.
Available with the Bianco Alaska, Perla, Grigio Seta, Lava finishes and in any of the lacquered colours. If matched with melamine grained or textured finishes, the colours are the same.

TREND T1 / T2 contenitori Trend / Trend storage units

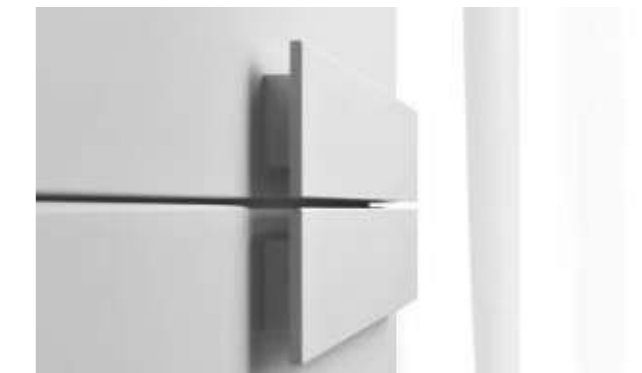

Disponibile nelle finiture Bianco Alaska, Perla, Grigio Seta, Lava e in tutti i colori laccati. Se abbinata a finiture melaminiche venate o materiche, la tinta è prevista in tonalità con la stessa.
Available with the Bianco Alaska, Perla, Grigio Seta, Lava finishes and in any of the lacquered colours. If matched with melamine

DREAM 1 / 2 contenitori Dream / Dream storage units



Disponibile nelle finiture Bianco Alaska, Perla, Grigio Seta, Lava e in tutti i colori laccati. Se abbinata a finiture melaminiche venate o materiche, la tinta è prevista in tonalità con la stessa.
Available with the Bianco Alaska, Perla, Grigio Seta, Lava finishes and in any of the lacquered colours. If matched with melamine

X3 contenitori Vip / Vip storage units



Disponibile nelle finiture Bianco Alaska, Perla, Grigio Seta, Lava e in tutti i colori laccati. Se abbinata a finiture melaminiche venate o materiche, la tinta è prevista in tonalità con la stessa.
Available with the Bianco Alaska, Perla, Grigio Seta, Lava finishes and in any of the lacquered colours. If matched with melamine

TETRIS

MANIGLIE HANDLES



Collezione notte disponibile nelle finiture melaminico, materico e in tutte le tonalità laccate opache e laccate opache a poro aperto, sia per la scocca che per i frontali cassetto. Apertura push-pull oppure maniglia W o profilo Gola.
 Bedroom collection available with a melamine or textured finish and in any of the matt lacquered and open pore matt lacquered finishes for the carcass and drawer fronts. Push-pull opening, W handle or Gola grip profile.

PUSH-PULL



L'apertura Push-Pull permette alle ante non avere fori maniglia garantendo comunque la massima praticità di apertura e chiusura. A Push-Pull handle avoids drilling the doors for handles and provides a highly practical opening and closing mechanism.

GOLA



Disponibile in tutti i colori laccati. Se abbinata a finiture melaminiche venate o materiche, la tinta è prevista in tonalità con la stessa. Available in any of the lacquered colours. If matched with melamine grained or textured finishes, the colours are the same.

W



Disponibile nelle finiture Bianco Alaska, Perla, Grigio Seta, Lava e in tutti i colori laccati. Se abbinata a finiture melaminiche venate o materiche, la tinta è prevista in tonalità con la stessa. Available with the Bianco Alaska, Perla, Grigio Seta, Lava finishes and in any of the lacquered colours. If matched with melamine grained or textured finishes, the colours are the same.

AIR

ingombro giroletto / bed frame space occupancy

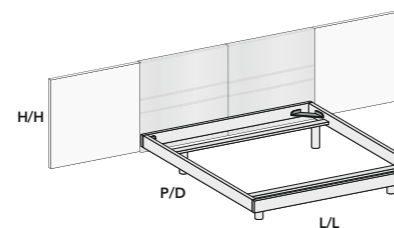

L/L1493 P/D2080 H/H343
L/L1694 P/D2080 H/H343
L/L1894 P/D2080 H/H343

Per le varianti di misure testata, giroletto e piedino, consultare il listino.
See the price list for different headboard, bed frame and leg measurements.

La testiera Air è un sistema di pannelli Boiserie fissati a muro mediante apposite attaccaglie, disponibili in tessuto, microfibra, melaminico, materico e in tutte le tonalità laccate opache e laccate opache a poro aperto; giroletto Right disponibile nelle finiture melaminico e nei colori laccati opachi e laccati opachi a poro aperto.

The Air headboard is a system of Boiserie panels attached to the wall, available in fabric, microfibre, melamine or textured finish and in any of the matt lacquered and open pore matt lacquered colours; Right bed frame comes with a melamine finish or in any of the matt lacquered and open pore matt lacquered colours.

CITY

ingombro / space occupancy

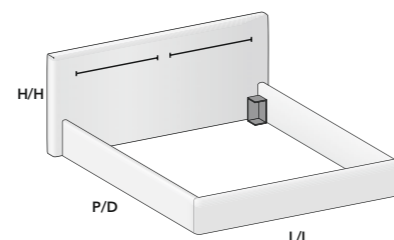

L/L1580 P/D2110 H/H1050
L/L1780 P/D2110 H/H1050
L/L1980 P/D2110 H/H1050

Per le varianti di giroletto e piedino, consultare il listino.
See the price list for different bed frames and legs.

Testiera City con rivestimento in tessuto o microfibra; giroletto Imbottito disponibile con rivestimento sempre in tessuto o microfibra.
City fabric or microfibre upholstered headboard; Padded bed frame available with fabric or microfibre upholstery.

CUBE LEGNO

ingombro / space occupancy

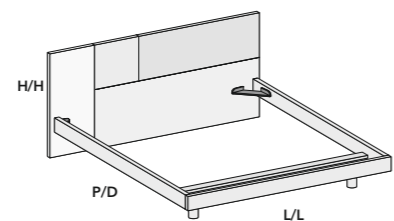

L/L1800 P/D2070 H/H1050
L/L2000 P/D2070 H/H1050
L/L2200 P/D2070 H/H1050

Per le varianti di giroletto e piedino, consultare il listino.
See the price list for different bed frames and legs.

Testiera Cube legno disponibile nelle finiture melaminico, materico e in tutte le tonalità laccate opache e laccate opache a poro aperto; giroletto Right disponibile nelle finiture melaminico e nei colori laccati opachi e laccati opachi a poro aperto.
Cube Legno headboard available with melamine or textured finish and in any of the matt lacquered and open pore matt lacquered colours; Right bed frame comes with a melamine finish or in any of the matt lacquered and open pore matt lacquered colours.

CUBE LEGNO CON INSERTO IMBOTTITO CUBE LEGNO WITH PADDED INSERT

ingombro / space occupancy

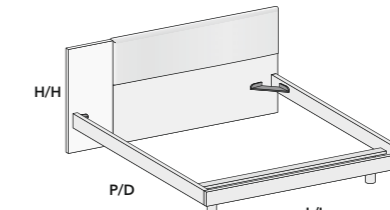

L/L1800 P/D2070 H/H1050
L/L2000 P/D2070 H/H1050
L/L2200 P/D2070 H/H1050

Per le varianti di giroletto e piedino, consultare il listino.
See the price list for different bed frames and legs.

Testiera Cube Legno con inserto imbottito rivestito in tessuto o microfibra, disponibile nelle finiture melaminico, materico e in tutte le tonalità laccate opache e laccate opache a poro aperto; giroletto Right disponibile nelle finiture melaminico e nei colori laccati opachi e laccati opachi a poro aperto.
Cube Legno with fabric or microfibre upholstered padded insert, available with melamine or textured finish and in any of the matt lacquered and open pore matt lacquered colours; Right bed frame comes with a melamine finish or in any of the matt lacquered and open pore matt lacquered colours.

ELEGANCE

ingombro / space occupancy

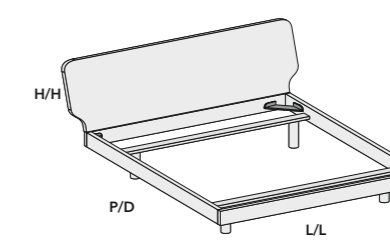

L/L1740 P/D2160 H/H1010
L/L1940 P/D2160 H/H1010
L/L2140 P/D2160 H/H1010

Per le varianti di giroletto e piedino, consultare il listino.
See the price list for different bed frames and legs.

Testiera Elegance, disponibile nelle finiture melaminico, materico e in tutte le tonalità laccate opache e laccate opache a poro aperto; giroletto Right disponibile nelle finiture melaminico e nei colori laccati opachi e laccati opachi a poro aperto.
Elegance headboard, available with melamine or textured finish and in any of the matt lacquered and open pore matt lacquered colours; the Right bed frame comes with melamine finish or any of the matt lacquered and open pore matt lacquered colours.

FLO

ingombro / space occupancy

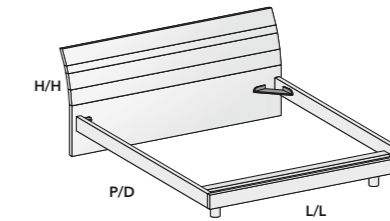

L/L1560 P/D2165 H/H1030
L/L1760 P/D2165 H/H1030
L/L1960 P/D2165 H/H1030

Per le varianti di giroletto e piedino, consultare il listino.
See the price list for different bed frames and legs.

Testiera Flo, disponibile nelle finiture melaminico, materico e in tutte le tonalità laccate opache e laccate opache a poro aperto; giroletto Right disponibile nelle finiture melaminico e nei colori laccati opachi e laccati opachi a poro aperto.
Flo headboard, available with melamine or textured finish and in any of the matt lacquered and open pore matt lacquered colours; Right bed frame comes with a melamine finish or in any of the matt lacquered and open pore matt lacquered colours.

LINE

ingombro / space occupancy

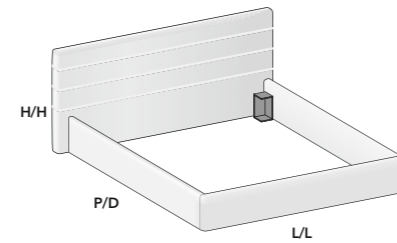

L/L1580 P/D2110 H/H1050
L/L1780 P/D2110 H/H1050
L/L1980 P/D2110 H/H1050

Per le varianti di giroletto e piedino, consultare il listino. See the price list for different bed frames and legs.

Testiera Line con rivestimento in tessuto o microfibra; giroletto Imbottito disponibile con rivestimento in tessuto o microfibra. Line headboard upholstered in fabric or microfibre; Imbottito bed frame available upholstered in fabric or microfibre.

STREET

ingombro / space occupancy

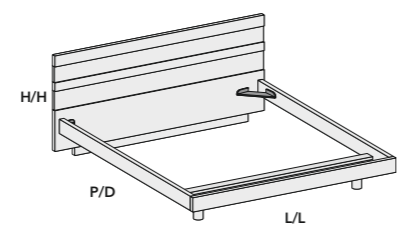

L/L1690 P/D2070 H/H970
L/L1890 P/D2070 H/H970
L/L2090 P/D2070 H/H970

Per le varianti di giroletto e piedino, consultare il listino. See the price list for different bed frames and legs.

Testiera Street, disponibile nelle finiture melaminico, materico e in tutte le tonalità laccate opache e laccate opache a poro aperto; giroletto Right disponibile nelle finiture melaminico e nei colori laccati opachi e laccati opachi a poro aperto. Street headboard, available with melamine or textured finish and in any of the matt lacquered and open pore matt lacquered colours; Right bed frame comes with a melamine finish or in any of the matt lacquered and open pore matt lacquered colours.

TIME

ingombro / space occupancy

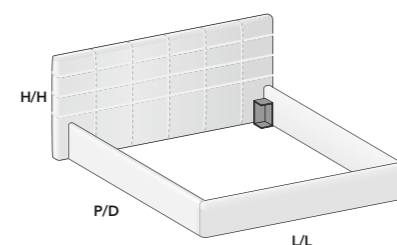

L/L1580 P/D2110 H/H1050
L/L1780 P/D2110 H/H1050
L/L1980 P/D2110 H/H1050

Per le varianti di giroletto e piedino, consultare il listino. See the price list for different bed frames and legs.

TestieraTime con rivestimento in tessuto o microfibra; giroletto Imbottito disponibile con rivestimento in tessuto o microfibra. Time headboard upholstered in fabric or microfibre; Imbottito bed frame available upholstered in fabric or microfibre.

TOGO

ingombro / space occupancy

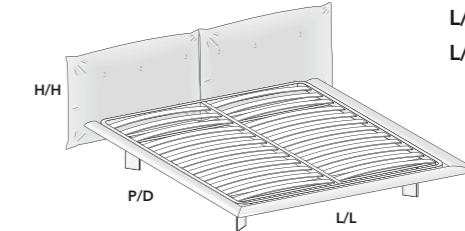

L/L1960 P/D2230 H/H900
L/L2160 P/D2230 H/H900

TestieraTogo imbottita con giroletto e rete strutturale, disponibili con rivestimento in tessuto o microfibra. Togo padded headboard with bed frame and structural base, available upholstered in fabric or microfibre.

TOMORROW

ingombro / space occupancy

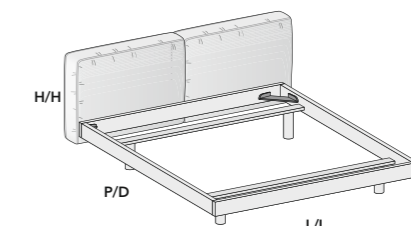

L/L1630 P/D2230 H/H1050
L/L1830 P/D2230 H/H1050
L/L2030 P/D2230 H/H1050

Per le varianti di giroletto e piedino, consultare il listino. See the price list for different bed frames and legs.

Testiera Tomorrow con rivestimento in tessuto o microfibra; giroletto Right disponibile nelle finiture melaminico e nei colori laccati opachi e laccati opachi a poro aperto. Tomorrow headboard upholstered in fabric or microfibre; Right bed frame comes with a melamine finish or in any of the matt lacquered and open pore matt lacquered colours.

MELAMINICO MELAMINE

Bianco Alaska

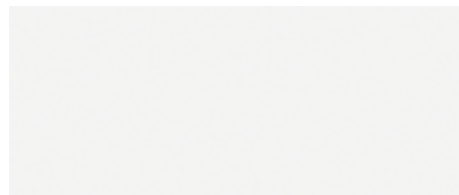

Perla

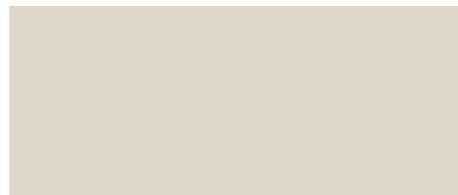

Grigio Seta

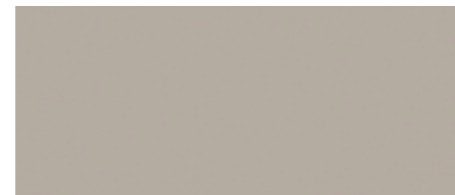

Olmo Bianco



Lava



MATERICO TEXTURED

Rovere Nodato Miele



Rovere Nodato Scuro



Olmo Cotto



SPECCHIO SPECCHIO

Chiaro



Fumè



LAMINAM® LAMINAM®

Calacatta Lucido



Pietra di Savoia



Noir Desir



LACCATO OPACO FINITURA SETA / FINITURA PORO APERTO MATT LACQUERED SILK FINISH / OPEN PORE FINISH

Bianco 9016

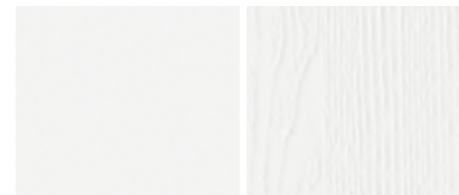

Perla A000



Senape 1005



Paprika 3560



Lava b000



Seta 0000



Mandorla 6005



Ardesia 5502



Ottanio 5020



Salvia 5010



Turchese 3050



Visone 7502



Cipria 1010



Nuvola r80b



Prugna 5010

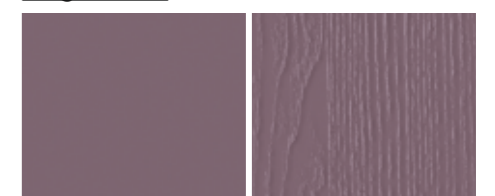

Cielo 4020



Acquamarina 2005



Oliva 6020



È possibile la laccatura in tutte le versioni della scala ral classic.
Can be lacquered in any of the colours in the RAL classic scale.

CARTE DA PARATI WALLPAPER

5.0 Art.01



5.0 Art.11



5.0 Art.16

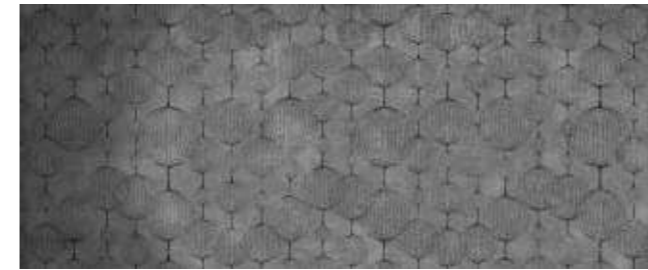

5.0 Art.05



5.0 Art.12



5.0 Art.17



5.0 Art.06



5.0 Art.13

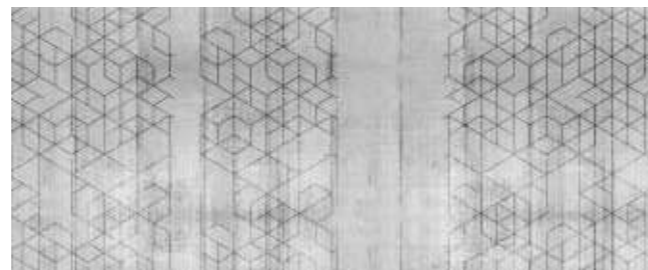

5.0 Art.18



5.0 Art.07



5.0 Art.14



5.0 Art.19



5.0 Art.10



5.0 Art.15



5.0 Art.20



GRAFICHE PER ANTE GRAPHICS FOR DOORS

Trama 1

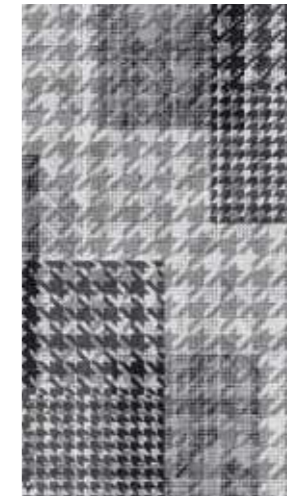

Ronbi 4



Soffio 2



Natura 4



Foglie 3



Spine 6



Project: **Cinquepuntozero lab**

Images: **Nerokubo**

Graphic design: **Lorella Agnoletto Designer**

Color separation: **GM Studio 1**

Print: **Grafiche Antiga**



a brand of SIGI s.r.l.

Via Toti dal Monte, 71 - 31050 Barbisano - TV - Italy - Tel. +39 0438 8391 - Fax. +39 0438 842361 - www.cinque-puntozero.it

100% MADE IN ITALY

SIGI s.r.l. si riserva in qualsiasi momento la facoltà di apportare tutte le modifiche necessarie al miglioramento funzionale e qualitativo dei propri prodotti. Per ogni aspetto tecnico e dimensionale fare riferimento ai listini aziendali e relativi aggiornamenti. I colori e i materiali riprodotti nelle immagini stampate hanno un valore indicativo.

SIGI s.r.l. reserves the right to make all the necessary changes for the functional or qualitative improvements of its products. For every technical and dimensional aspect, please refer to the company pricelists and their relative updates. The colours and materials reproduced in printed images are indicative.